

JOIN OUR UMBRELLA.

# PROTECTING YOUR PRODUCT & CARGO IS OUR PRIORITY



## Starsage Packaging



Adhesive Tapes



Air Bubble Wrap



Clay Desiccants



Silica Gel



Dunnage Air Bags



Ethylene Absorbers



Oxygen Absorbers



Plastic Pallets



Steel Pallets



Biodegradable Bags

[www.starsage.lk](http://www.starsage.lk)

 **Starsage**  
Protecting our exports since 2015.

## PLASTIC PALLETS

Starsage Packaging act as a one-stop-shop for packaging materials for shipping and warehousing, providing total solutions under one roof offering the best quality products to our valuable customers. We are engaged in providing complete integrated packaging solutions, right from design to delivery. Our Packaging Materials guarantees great results and solutions. Starsage priorities on time deliveries and a quality customer care to educate our customers by providing the relevant technical knowledge to handle our Packaging Materials most efficiently and effectively.



### Some of our clients

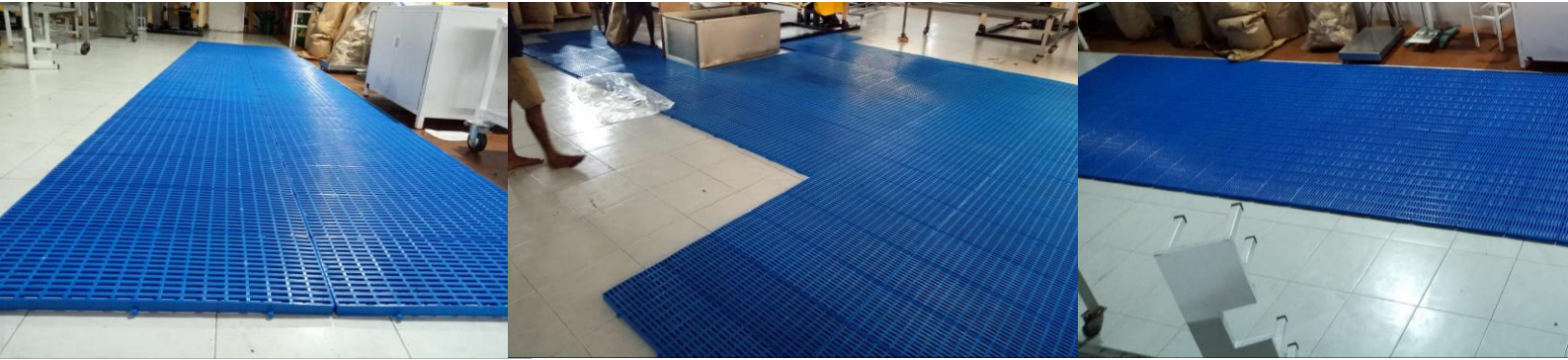

Plastic floor bed for a DC coconut oil factory in Minuwangoda, Sri Lanka.



Plastic racking flatbed pallets for an activated carbon factory in Nattandiya, Sri Lanka.



Plastic racking nest bed pallets for a tea warehouse in Wattala, Sri Lanka.



**ST-06 | FLOOR PALLET**



MADE IN U.A.E



Bottom View

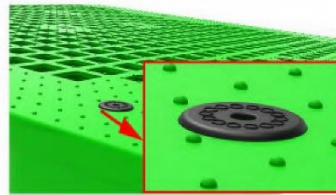

Rubber Bush & Bubble Surface For Anti Slip



Suitable for truck flooring

**TECHNICAL SPECIFICATION**

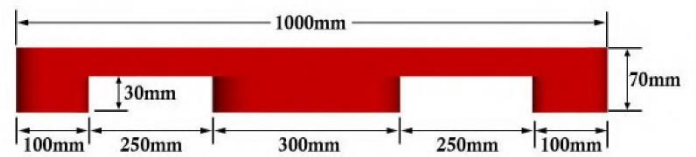
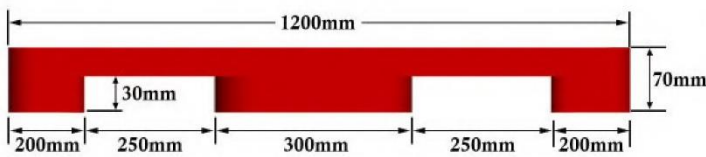

**TECHNICAL DATA**

<b>TECHNICAL DATA</b>			
Dimension(mm)	L:1200 x W:1000 x H:70		
Material	HDPE / PP		
Color			
Loading Capacity (Kgs) : ST-06	STATIC	DYNAMIC	RACKING
	4000 Kg	1000 Kg	N/A
Item Code / Barcode			

Load Quantity	20 ft	40 ft	Trailer Truck
	300 pcs	600 pcs	700 pcs

**ST-07 | REVERSIBLE**

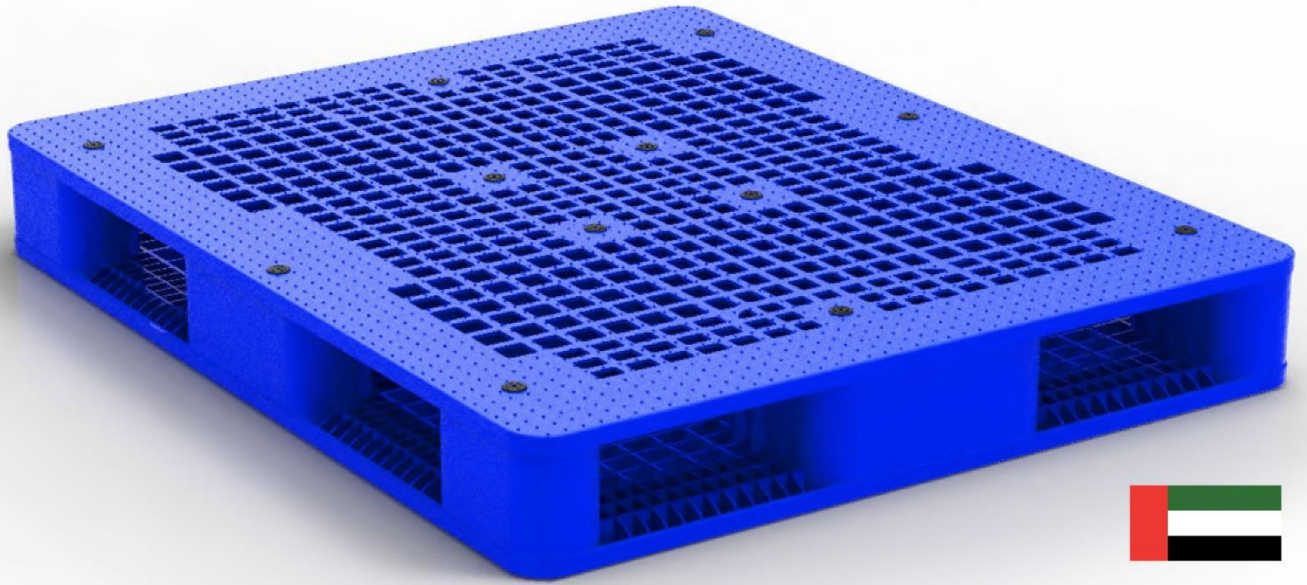

MADE IN U.A.E

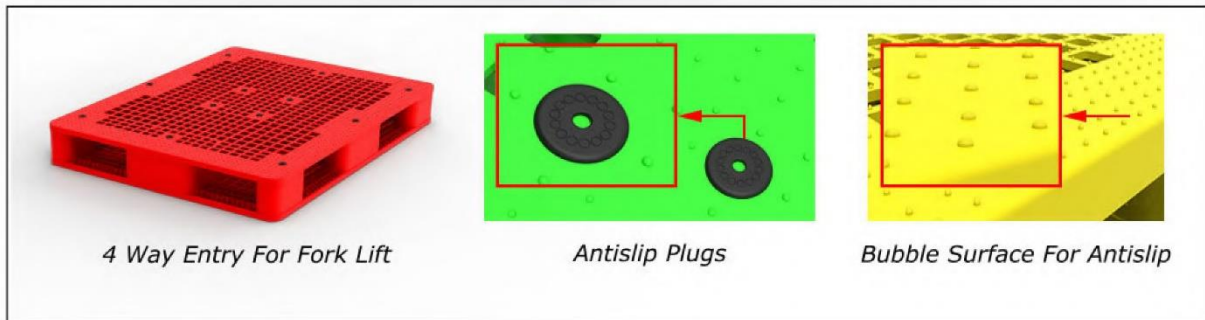



4 Way Entry For Fork Lift

Antislip Plugs

Bubble Surface For Antislip

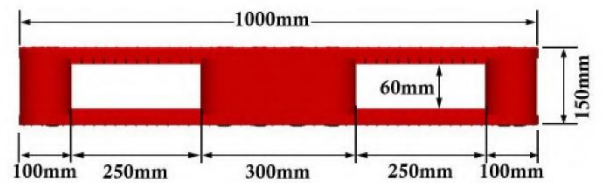
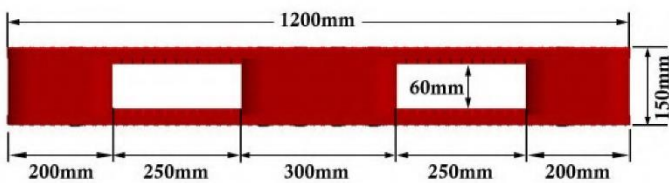
**TECHNICAL SPECIFICATION**



TECHNICAL DATA			
Dimension(mm)	L:1200 x W:1000 x H:150		
Material	HDPE / PP		
Color			
Loading Capacity (Kgs) : ST-07	STATIC	DYNAMIC	RACKING
	6000 Kg	1500 Kg	1500 Kg*
Item Code / Barcode	*Depend on span width		

Load Quantity	20 ft	40 ft	Trailer Truck
	160 pcs	370 pcs	450 pcs

# ST-08 | 3RUNNER

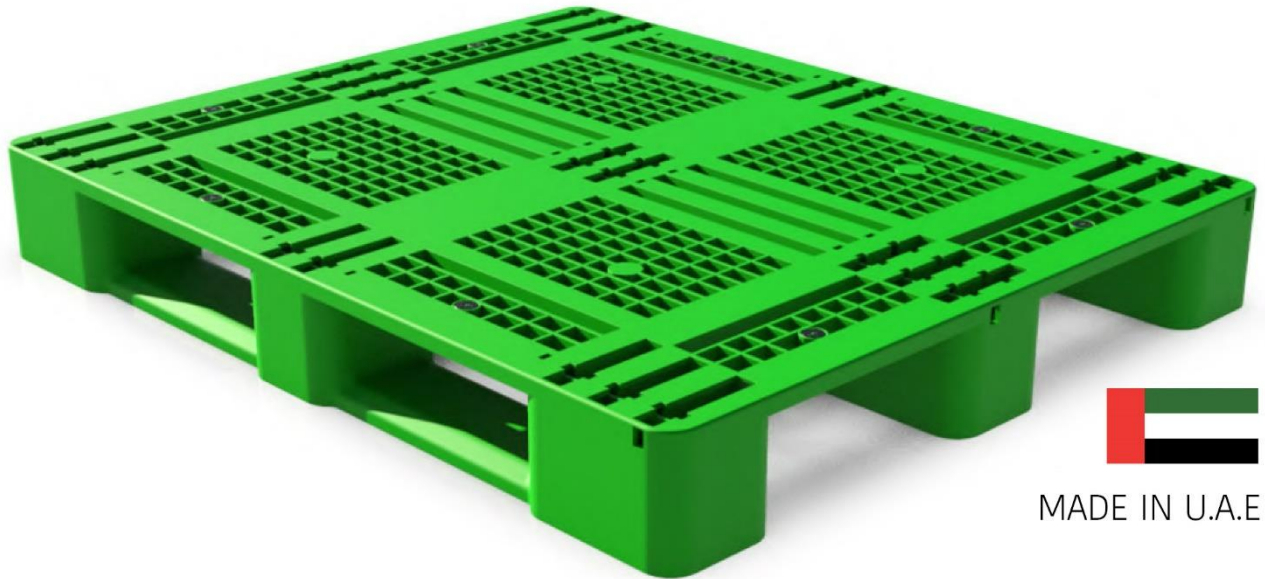

MADE IN U.A.E



### TECHNICAL SPECIFICATION

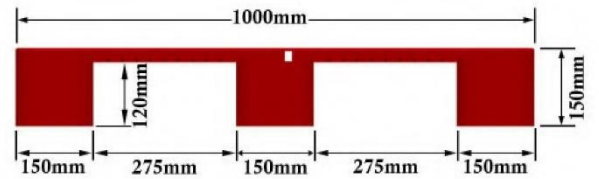
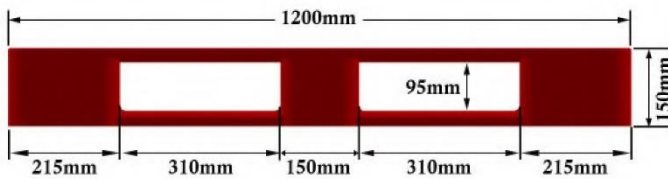

TECHNICAL DATA			
Dimension(mm)	L:1200 x W:1000 x H:150		
Material	HDPE / PP		
Color			
Loading Capacity (Kgs) : ST08 3R	STATIC	DYNAMIC	RACKING
	4000 Kg	1000 Kg	N/A
Item Code / Barcode			

Load Quantity	20 ft	40 ft	Trailer Truck
	225 pcs	520 pcs	560 pcs

**ST-08 | 3RUNNER**  
WITH METAL REINFORCEMENT

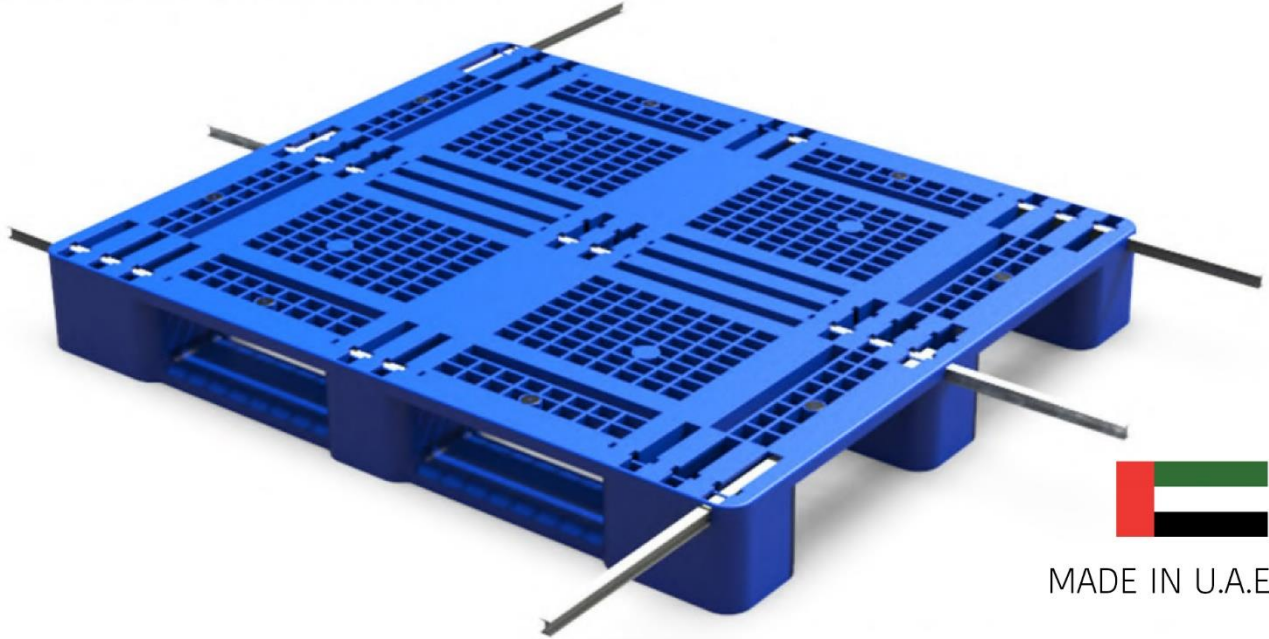

MADE IN U.A.E

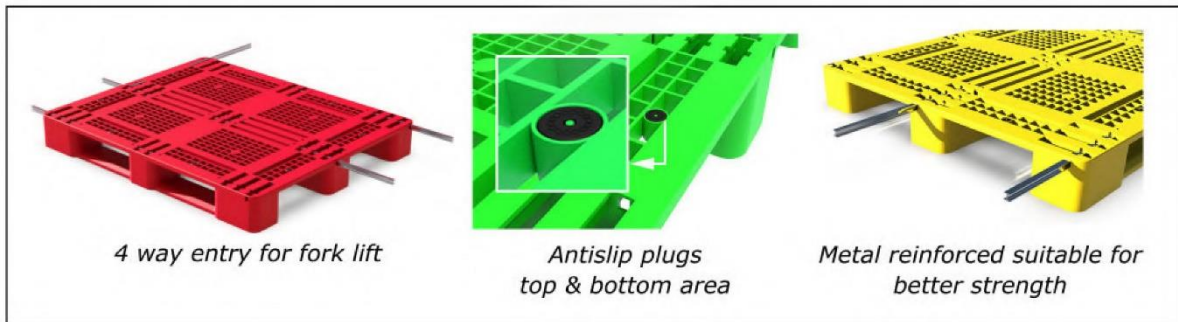

4 way entry for fork lift

Antislip plugs top & bottom area

Metal reinforced suitable for better strength

**TECHNICAL SPECIFICATION**

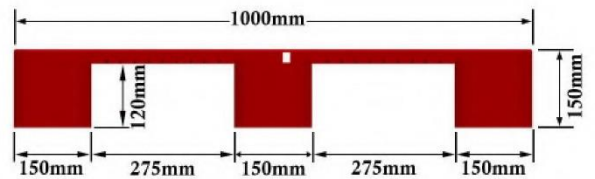
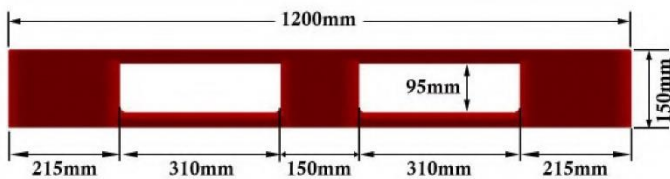

**TECHNICAL DATA**

Dimension(mm)	L:1200 x W:1000 x H:150		
Material	HDPE / PP		
Color			
Loading Capacity (Kgs) : ST08 3R (6 metal bar)	STATIC	DYNAMIC	RACKING
	6000 Kg	1500 Kg	1250 Kg*
Item Code / Barcode			

Load Quantity	20 ft	40 ft	Trailer Truck
	225 pcs	520 pcs	560 pcs

**ST-08 | 5RUNNER**



MADE IN U.A.E

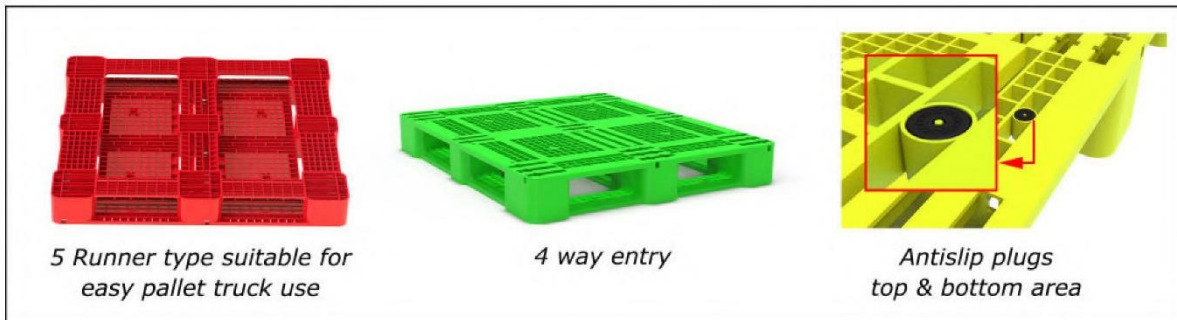

**TECHNICAL SPECIFICATION**

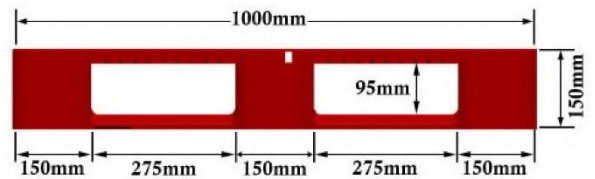
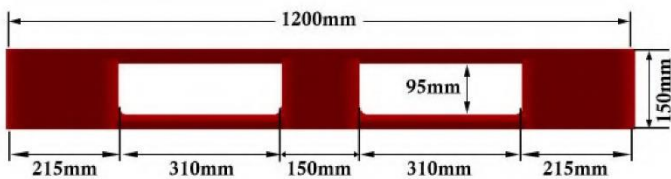

TECHNICAL DATA			
Dimension(mm)	L:1200 x W:1000 x H:150		
Material	HDPE / PP		
Color			
Loading Capacity (Kgs) : ST08 5R	STATIC	DYNAMIC	RACKING
	4000 Kg	1000 Kg	800 Kg*
Item Code / Barcode			

\*Depend on span width

Load Quantity	20 ft	40 ft	Trailer Truck
	160 pcs	370 pcs	450 pcs

**ST-08 | 5RUNNER**  
WITH METAL REINFORCEMENT



MADE IN U.A.E

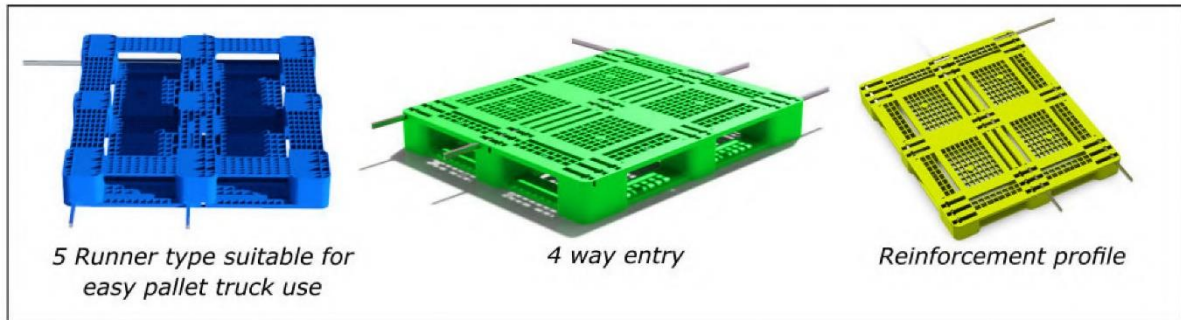

5 Runner type suitable for easy pallet truck use

4 way entry

Reinforcement profile

**TECHNICAL SPECIFICATION**

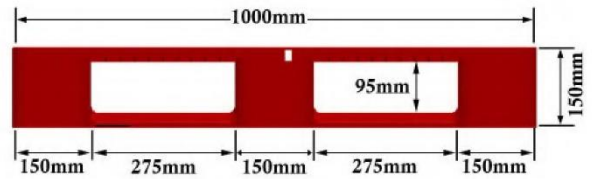
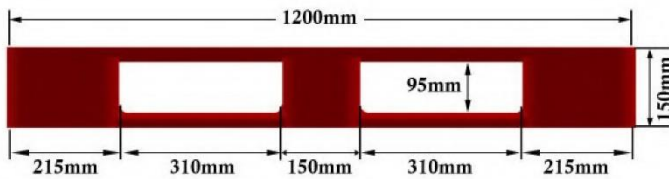

**TECHNICAL DATA**

Dimension(mm)	L:1200 x W:1000 x H:150		
Material	HDPE / PP		
Color			
Loading Capacity (Kgs) : ST08 5R (6 metal bar)	STATIC	DYNAMIC	RACKING
	6000 Kg	1500 Kg	1250 Kg*
Item Code / Barcode	*Depend on span width		

Load Quantity	20 ft	40 ft	Trailer Truck
	160 pcs	370 pcs	450 pcs



**ST-09 | 3RUNNER**

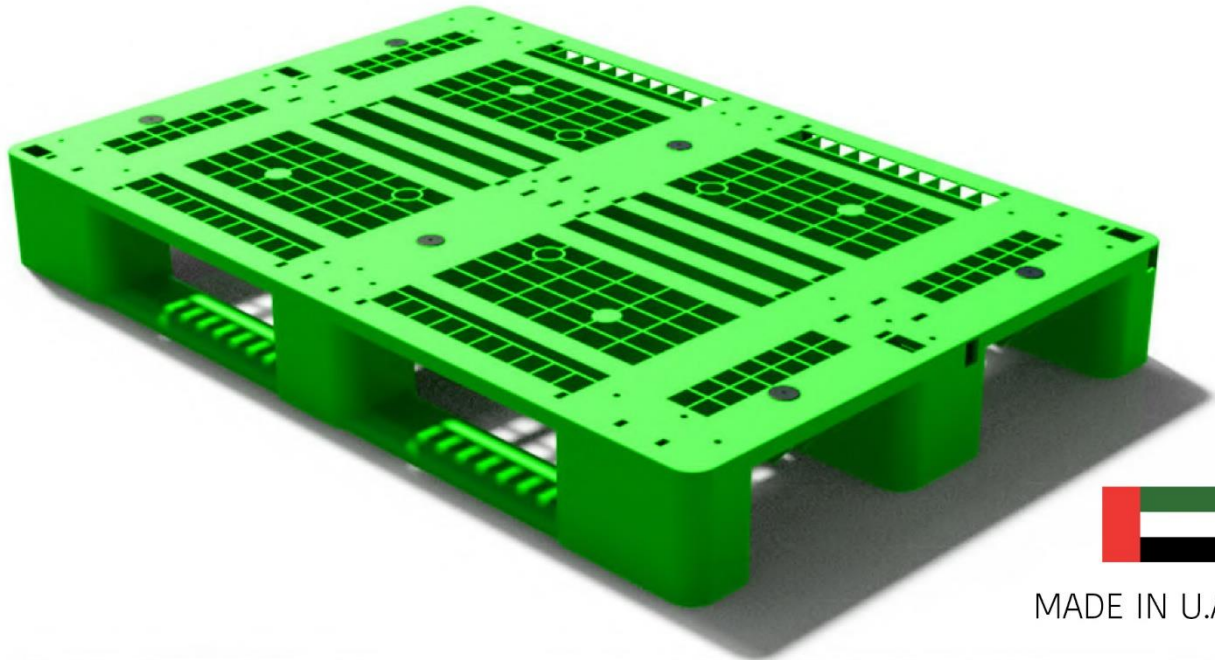

MADE IN U.A.E

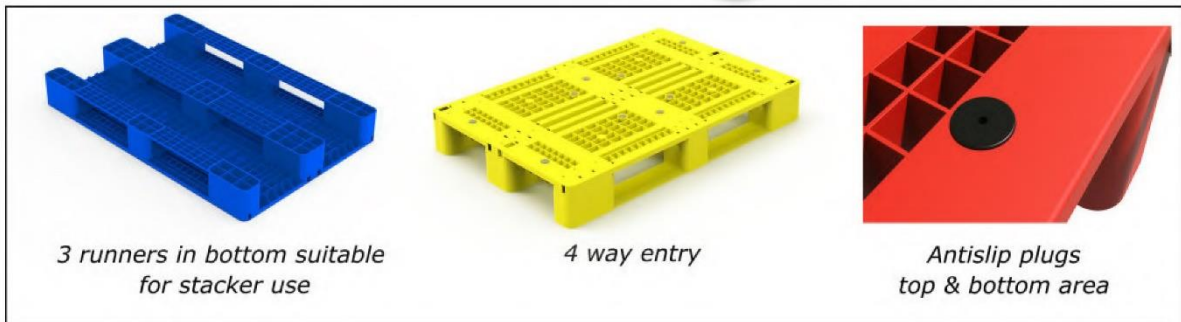

**TECHNICAL SPECIFICATION**

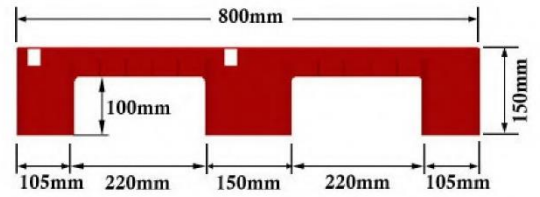
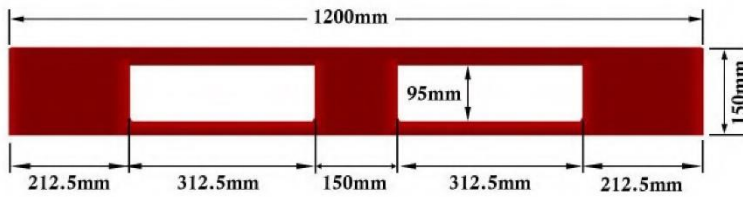

**TECHNICAL DATA**

Dimension(mm)	L:1200 x W:800 x H:150		
Material	HDPE / PP		
Color			
Loading Capacity (Kgs) : ST09 3R	STATIC	DYNAMIC	RACKING
	4000 Kg	1000 Kg	N/A
Item Code / Barcode			

Load Quantity	20 ft	40 ft	Trailer Truck
	250 pcs	540 pcs	600 pcs

# ST-09 | 3RUNNER

WITH METAL REINFORCEMENT

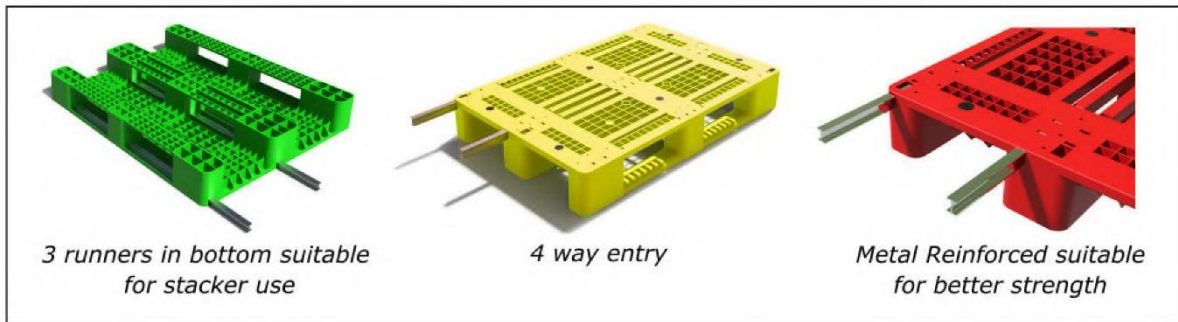
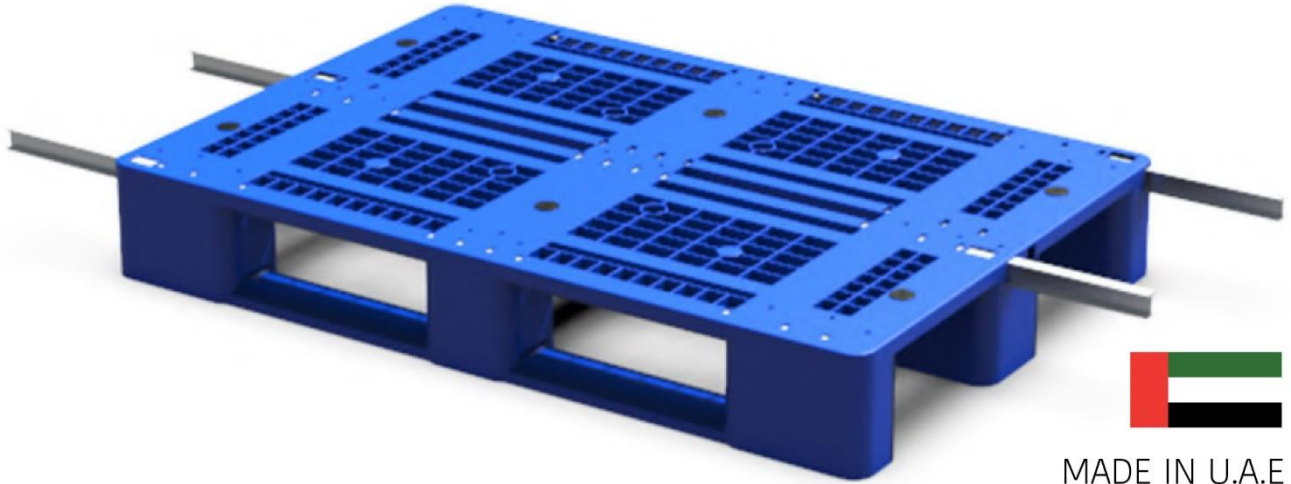

### TECHNICAL SPECIFICATION

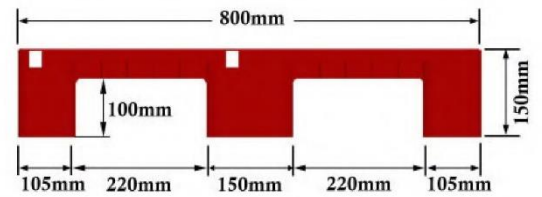
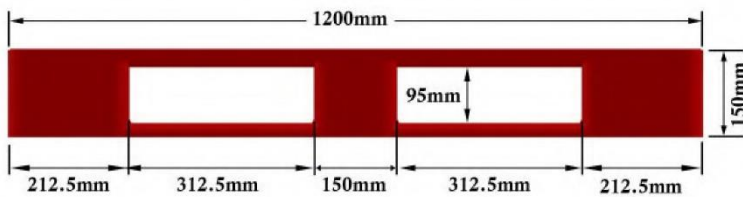

TECHNICAL DATA			
Dimension(mm)	L:1200 x W:800 x H:150		
Material	HDPE / PP		
Color			
Loading Capacity (Kgs) : ST09 3R (4 metal bar)	STATIC	DYNAMIC	RACKING
	5000 Kg	1500 Kg	1500 Kg*
Item Code / Barcode			

Load Quantity	20 ft	40 ft	Trailer Truck
	250 pcs	540 pcs	600 pcs

# ST-10 | 6RUNNER

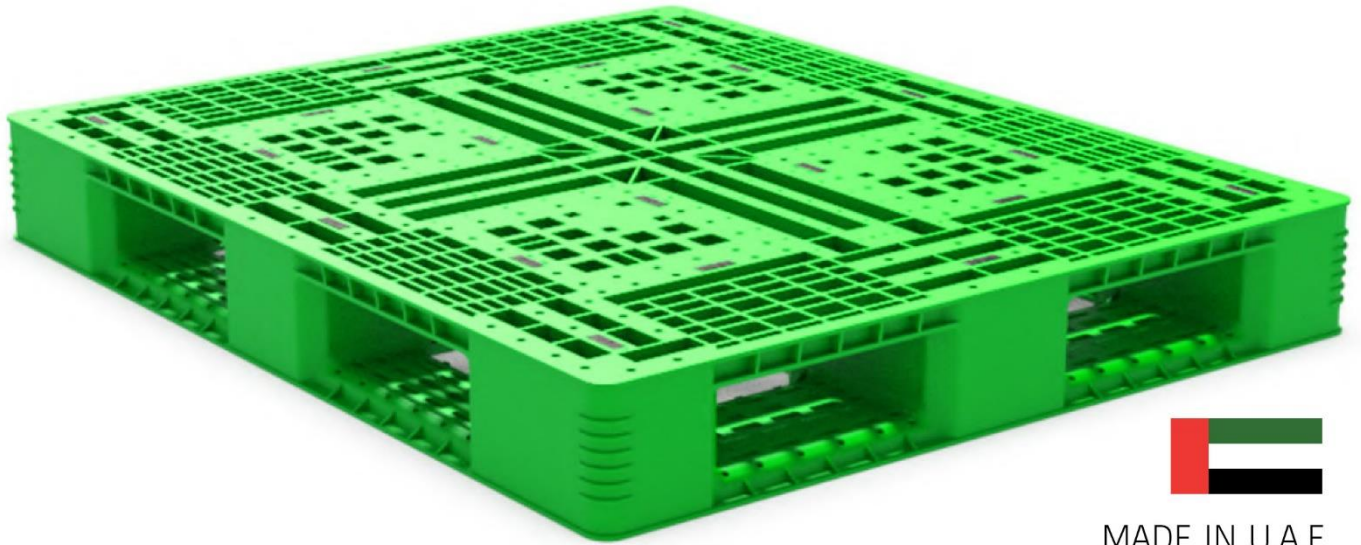

MADE IN U.A.E



6 Runners at the bottom



Antislip Plugs



Suitable for Racking

### TECHNICAL SPECIFICATION

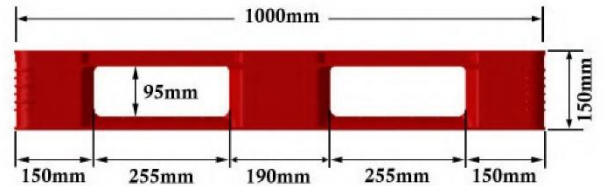
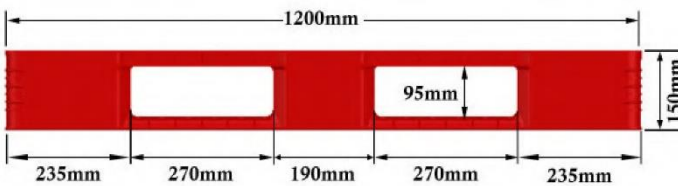

TECHNICAL DATA			
Dimension(mm)	L:1200 x W:1000 x H:150		
Material	HDPE / PP		
Color	<span style="color: blue;">●</span> <span style="color: green;">●</span> <span style="color: red;">●</span> <span style="color: yellow;">●</span> <span style="color: black;">●</span> <span style="color: gray;">●</span>		
Loading Capacity (Kgs) : ST-10 6R	STATIC	DYNAMIC	RACKING
	6000 Kg	1500 Kg	1000 Kg*
Item Code / Barcode			

\*depends upon the span width

Load Quantity	20 ft	40 ft	Trailer Truck
	155 pcs	375 pcs	430 pcs

**ST-11 | 3RUNNER**



MADE IN U.A.E



Bottom view

Anti-slip Plugs

3 Runners at the bottom

**TECHNICAL SPECIFICATION**

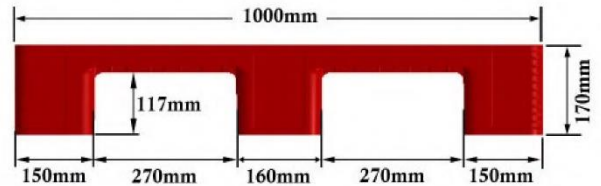
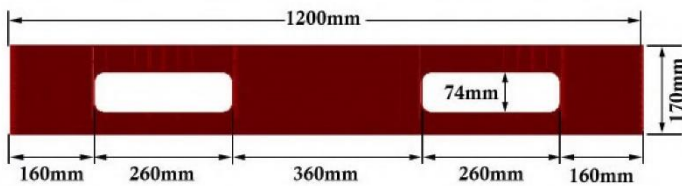

**TECHNICAL DATA**

<b>TECHNICAL DATA</b>			
Dimension(mm)	L:1200 x W:1000 x H:170		
Material	HDPE / PP		
Color			
Loading Capacity (Kgs) : ST-11	STATIC	DYNAMIC	RACKING
	6000 Kg	1500 Kg	1000 Kg*
Item Code / Barcode			

\*depends upon the span width

Load Quantity	20 ft	40 ft	Trailer Truck
	175 pcs	460 pcs	420 pcs

**ST-12 | 3RUNNER**



MADE IN U.A.E

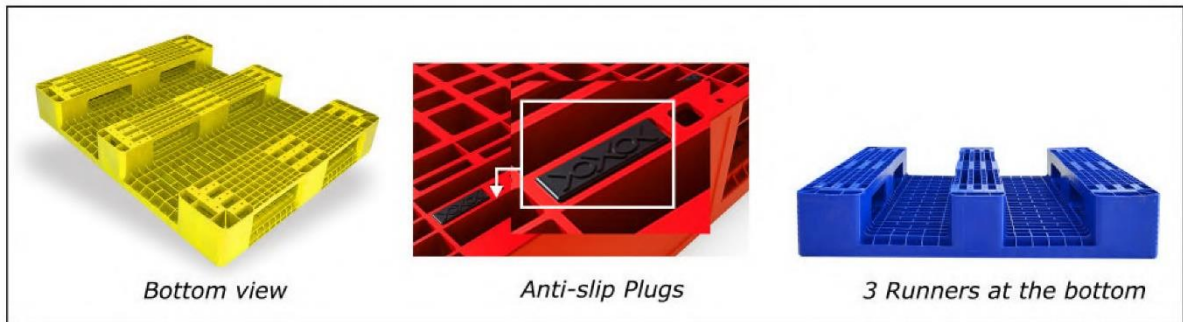

Bottom view

Anti-slip Plugs

3 Runners at the bottom

**TECHNICAL SPECIFICATION**

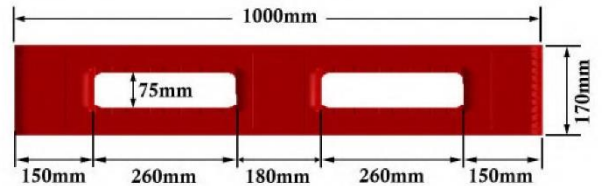
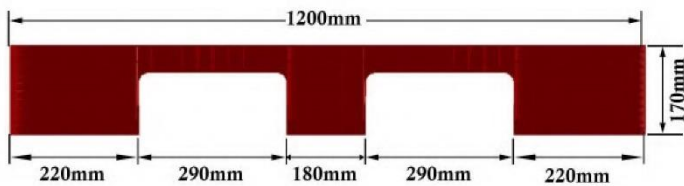

**TECHNICAL DATA**

Dimension(mm)	L:1200 x W:1000 x H:170		
Material	HDPE / PP		
Color			
Loading Capacity (Kgs) : ST-12 3R	STATIC	DYNAMIC	RACKING
	6000 Kg	1500 Kg	1000 Kg*
Item Code / Barcode	*depends upon the span width		

Load Quantity	20 ft	40 ft	Trailer Truck
	135 pcs	420 pcs	420 pcs

# ST-13 | 3RUNNER



MADE IN U.A.E

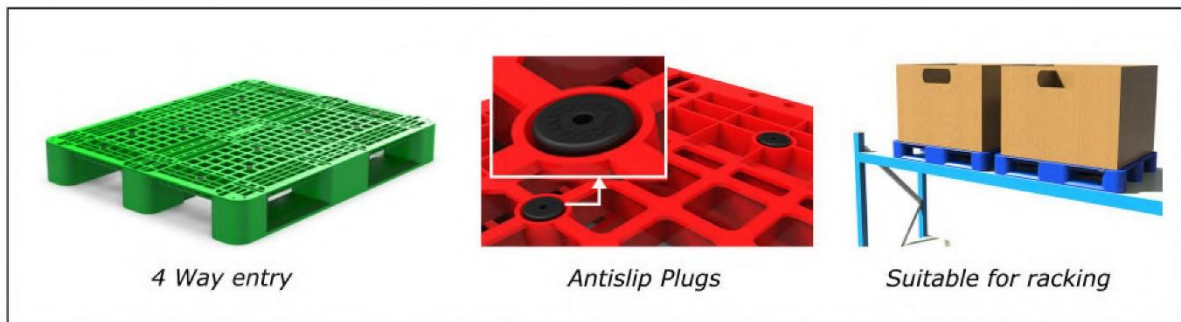

### TECHNICAL SPECIFICATION

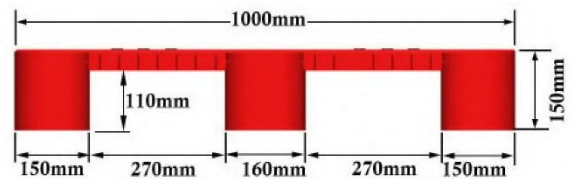
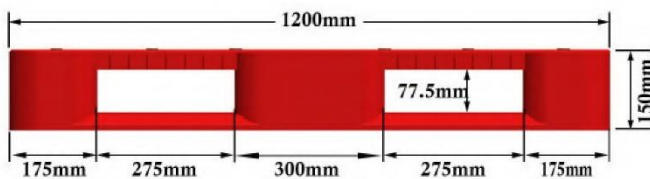

### TECHNICAL DATA

Dimension(mm)	L:1200 x W:1000 x H:150		
Material	HDPE / PP		
Color			
Loading Capacity (Kgs) : ST-13 3R	STATIC	DYNAMIC	RACKING
	5000 Kg	1000 Kg	1000 Kg*
Item Code / Barcode	*depends upon the span width		

Load Quantity	20 ft	40 ft	Trailer Truck
	155 pcs	375 pcs	430 pcs

**ST-13 | 3RUNNER**  
WITH METAL REINFORCEMENT

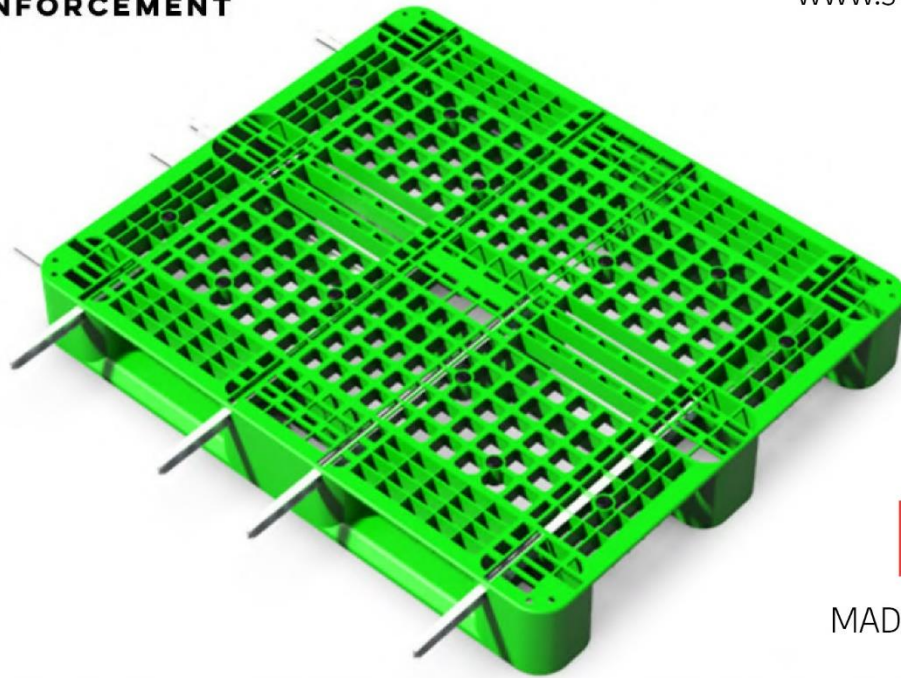

MADE IN U.A.E

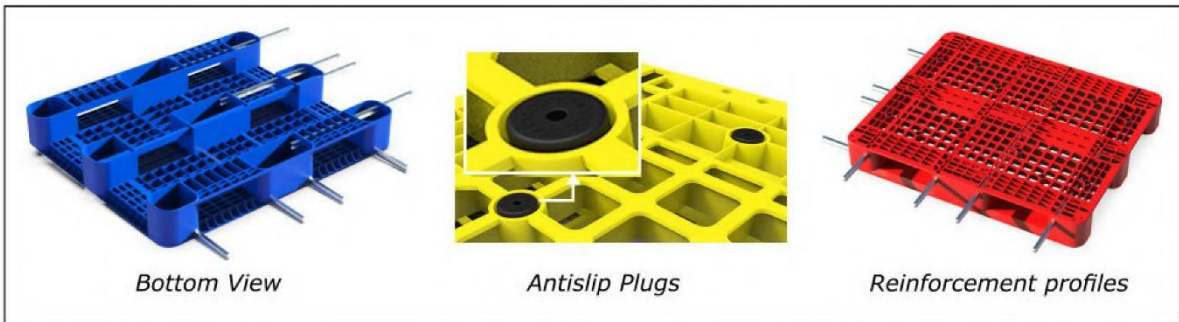

**TECHNICAL SPECIFICATION**

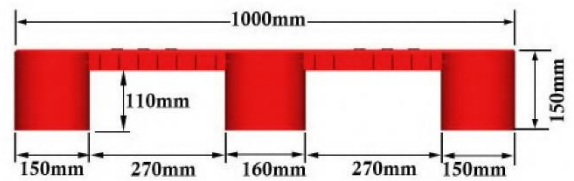
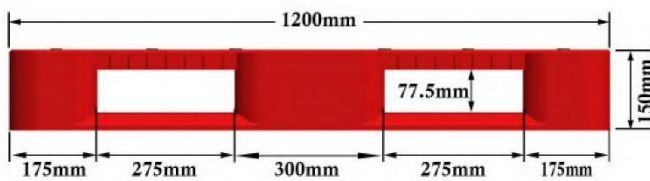

**TECHNICAL DATA**

Dimension(mm)	L:1200 x W:1000 x H:150		
Material	HDPE / PP		
Color			
Loading Capacity (Kgs) : ST-13 3R (With 8 Metal Bar)	STATIC	DYNAMIC	RACKING
	6000 Kg	1500 Kg	1250 Kg*
Item Code / Barcode			

Load Quantity	20 ft	40 ft	Trailer Truck
	155 pcs	375 pcs	430 pcs

**ST-13 | 5RUNNER**



MADE IN U.A.E

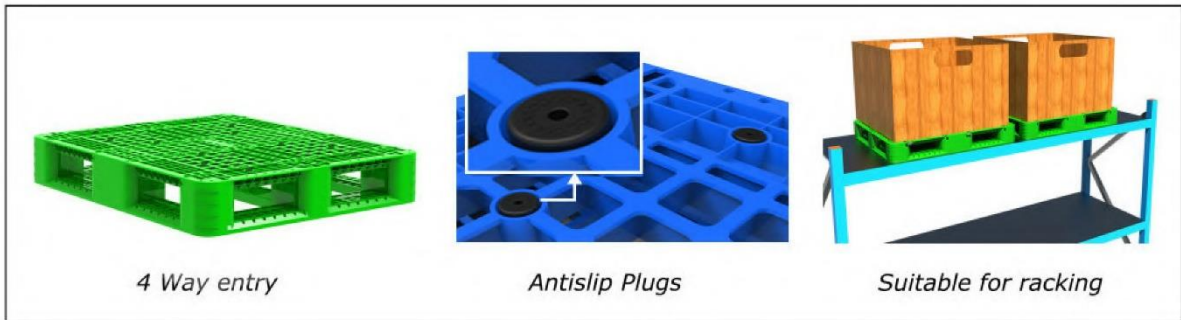

4 Way entry

Antislip Plugs

Suitable for racking

**TECHNICAL SPECIFICATION**

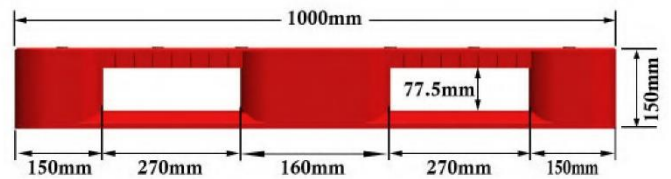
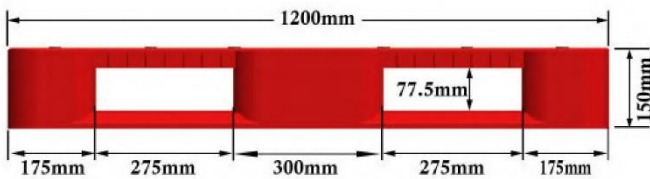

**TECHNICAL DATA**

Dimension(mm)	L:1200 x W:1000 x H:150		
Material	HDPE / PP		
Color			
Loading Capacity (Kgs) : ST-13 5R	STATIC	DYNAMIC	RACKING
	5000 Kg	1500 Kg	1000 Kg*
Item Code / Barcode	*depends upon the span width		

Load Quantity	20 ft	40 ft	Trailer Truck
	155 pcs	375 pcs	430 pcs



**ST-13 | 5RUNNER**  
WITH METAL REINFORCEMENT



MADE IN U.A.E

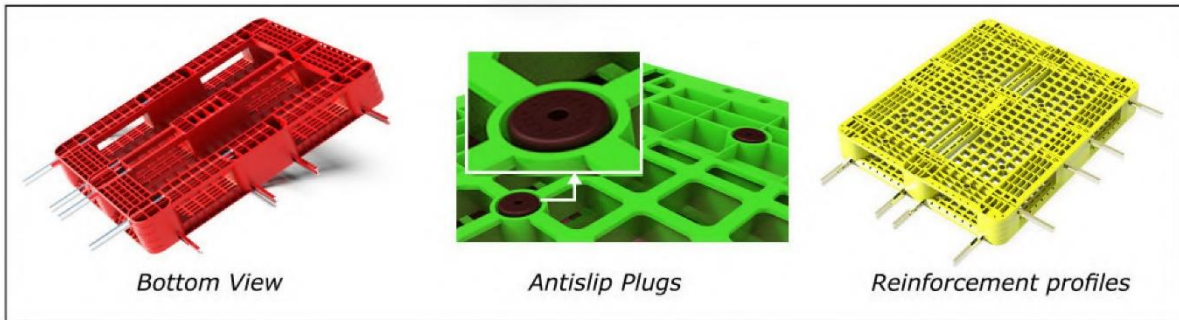

Bottom View

Antislip Plugs

Reinforcement profiles

**TECHNICAL SPECIFICATION**

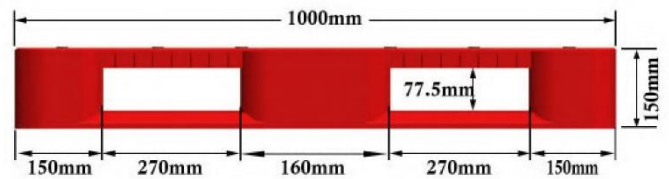
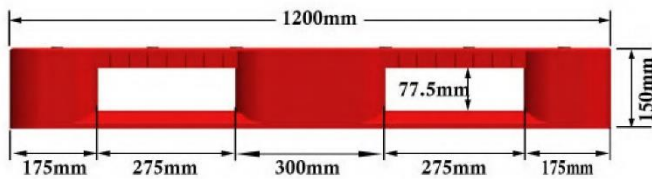

**TECHNICAL DATA**

Dimension(mm)	L:1200 x W:1000 x H:150		
Material	HDPE / PP		
Color			
Loading Capacity (Kgs) : ST-13 5R (With 8 Metal Bar)	STATIC	DYNAMIC	RACKING
	6000 Kg	1500 Kg	1500 Kg*
Item Code / Barcode			

Load Quantity	20 ft	40 ft	Trailer Truck
	155 pcs	375 pcs	430 pcs

**ST-14 | 9 LEGGED**

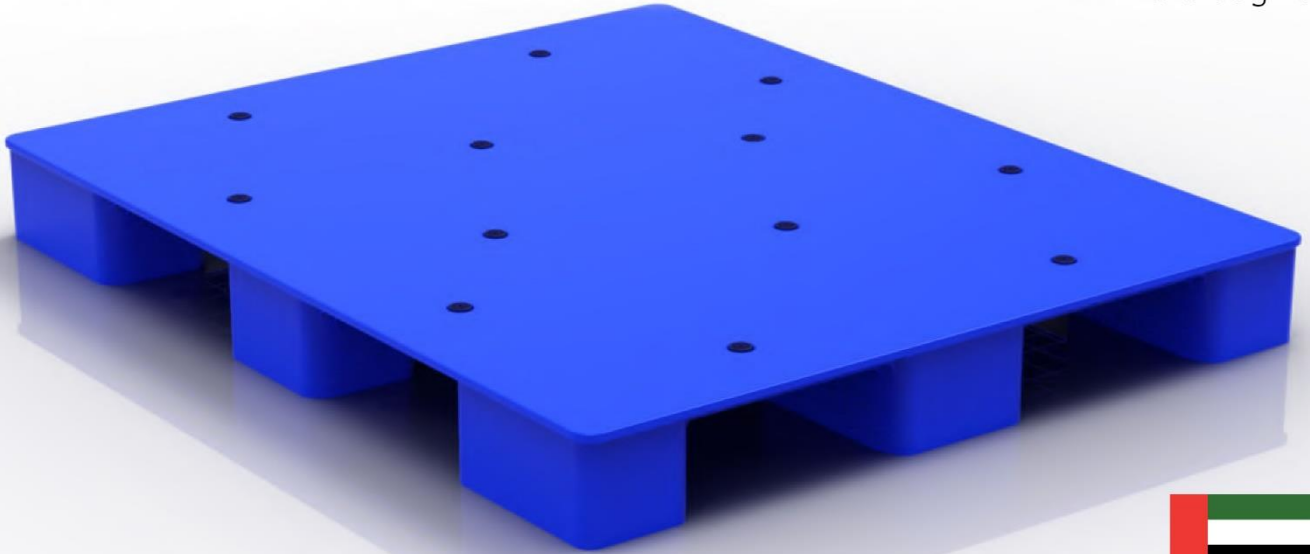

MADE IN U.A.E

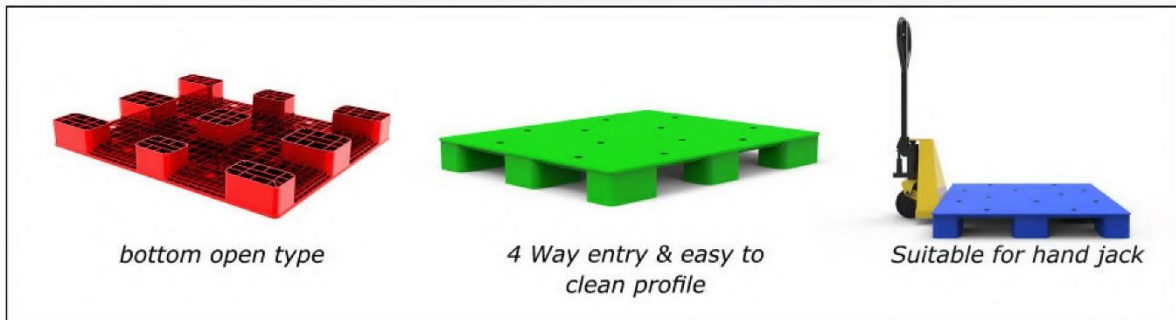



bottom open type

4 Way entry & easy to clean profile

Suitable for hand jack

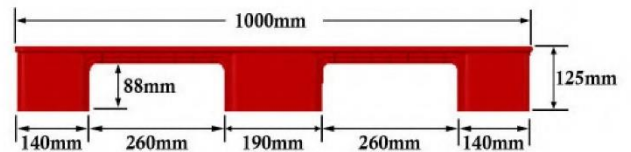
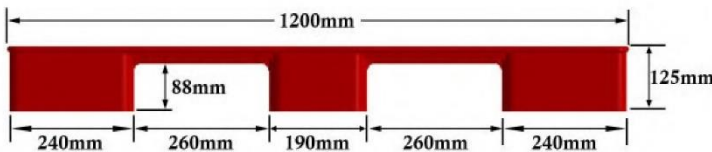
**TECHNICAL SPECIFICATION**



TECHNICAL DATA			
Dimension(mm)	L:1200 x W:1000 x H:125		
Material	HDPE / PP		
Color			
Loading Capacity (Kgs) : ST-14	STATIC	DYNAMIC	RACKING
	4000 Kg	1000 Kg	N/A
Item Code / Barcode			

Load Quantity	20 ft	40 ft	Trailer Truck
	225 pcs	600 pcs	700 pcs

# ST-16 | 6RUNNERS



MADE IN U.A.E

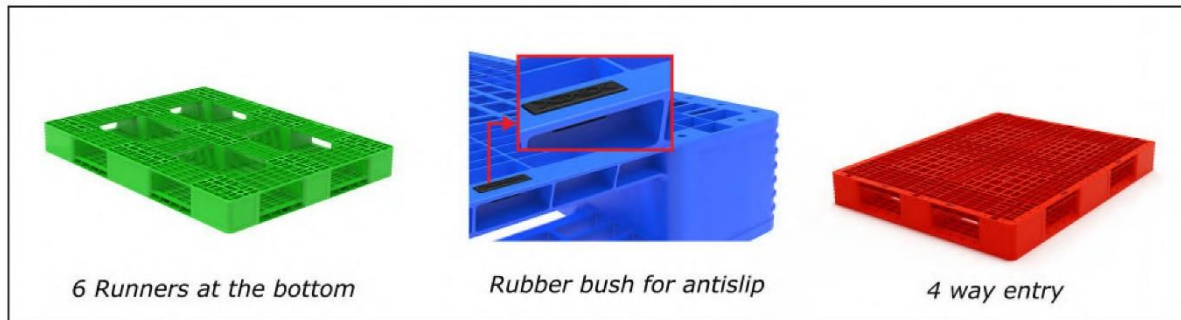

6 Runners at the bottom

Rubber bush for anti-slip

4 way entry

### TECHNICAL SPECIFICATION

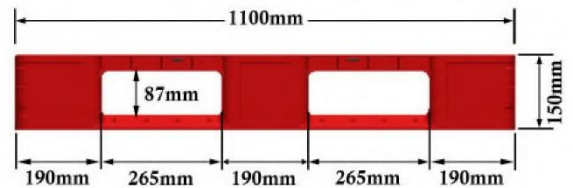
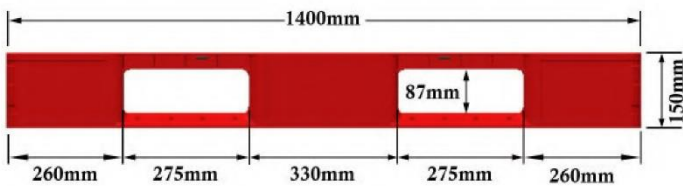

### TECHNICAL DATA

Dimension(mm)	L:1400 x W:1100 x H:150		
Material	HDPE / PP		
Color			
Loading Capacity (Kgs) : ST-16 6R	STATIC	DYNAMIC	RACKING
	5000 Kg	1500 Kg	1000 Kg*
Item Code / Barcode	*depends upon the span width		

Load Quantity	20 ft	40 ft	Trailer Truck
	85 pcs	280 pcs	320 pcs

**ST-15 | 6RUNNERS**



MADE IN U.A.E

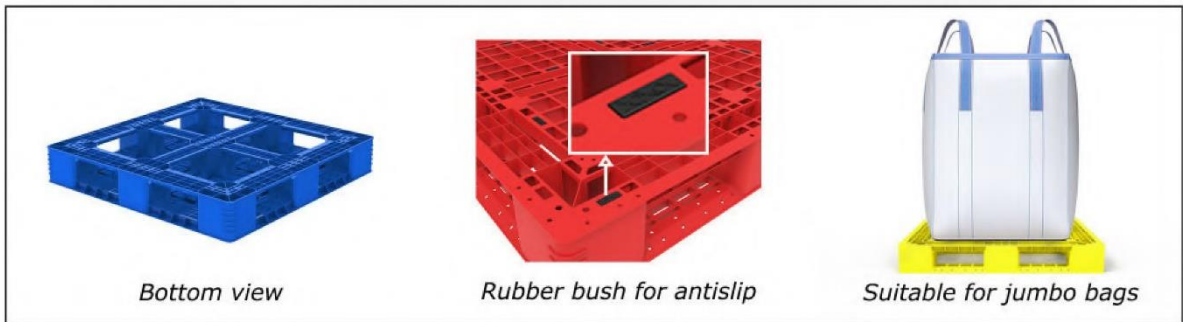

Bottom view

Rubber bush for antislip

Suitable for jumbo bags

**TECHNICAL SPECIFICATION**

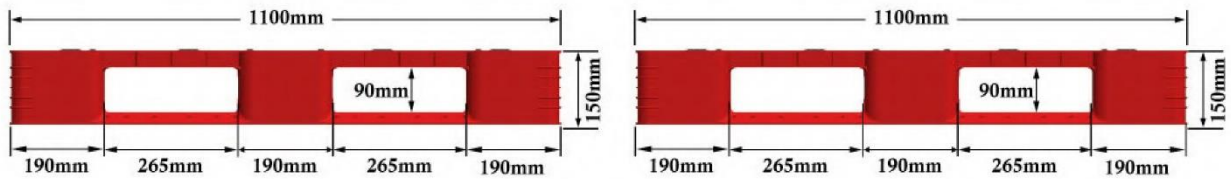

TECHNICAL DATA			
Dimension(mm)	L:1100 x W:1100 x H:150		
Material	HDPE / PP		
Color	<span style="color:blue">●</span> <span style="color:green">●</span> <span style="color:red">●</span> <span style="color:yellow">●</span> <span style="color:black">●</span> <span style="color:grey">●</span>		
Loading Capacity (Kgs) : ST-15 6R	STATIC	DYNAMIC	RACKING
	3000 Kg	1300 Kg	N/A
Item Code / Barcode			

Load Quantity	20 ft	40 ft	Trailer Truck
	150 pcs	360 pcs	450 pcs

# ST-17 | JUMBO BAG PALLET

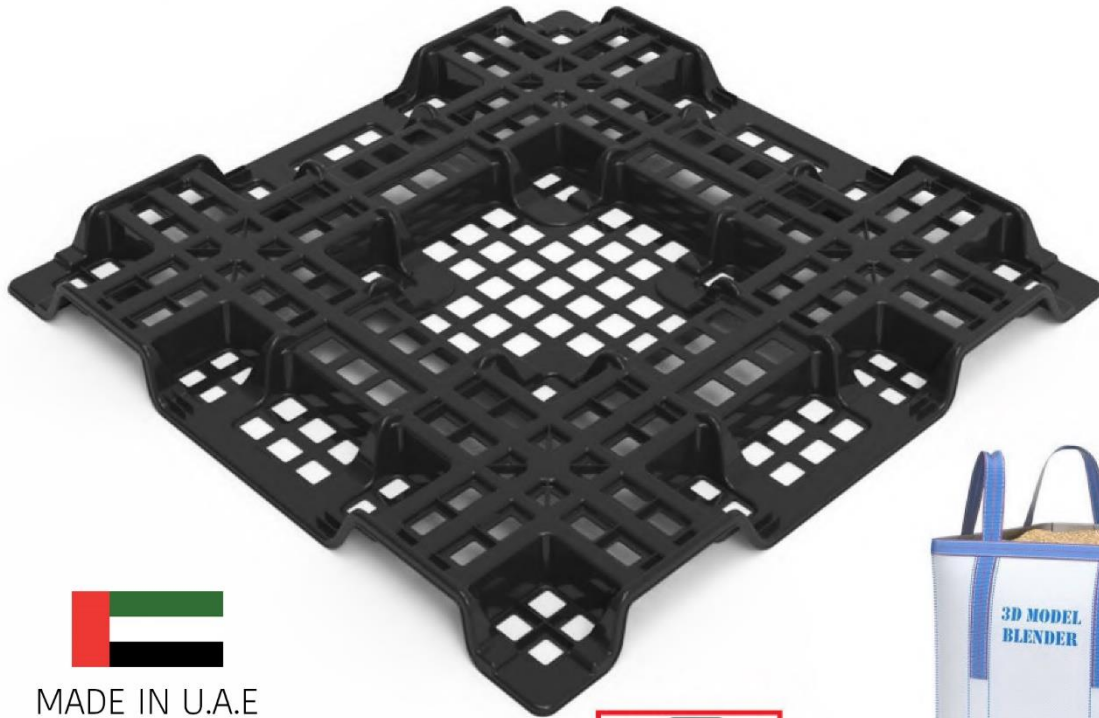

MADE IN U.A.E



Very low space consumption due to stackable nature



Used for handling jumbo bags

### TECHNICAL SPECIFICATION

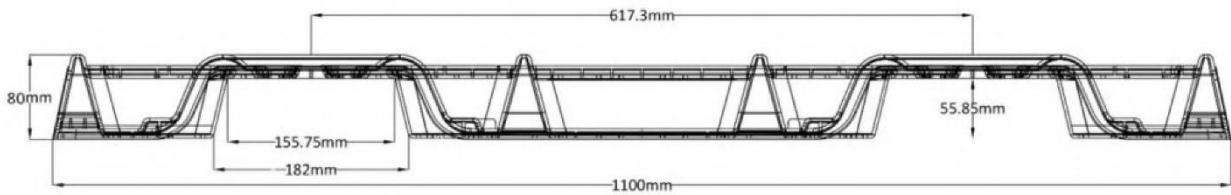

### TECHNICAL DATA

<b>TECHNICAL DATA</b>			
Dimension(mm)	L:1100 x W:1100 x H:80		
Material	HDPE / PP		
Color			
Loading Capacity (Kgs) : ST-17	STATIC	DYNAMIC	RACKING
	3000 Kg	1500 Kg	N/A
Item Code / Barcode			

Load Quantity	20 ft	40 ft	Trailer Truck
	550 pcs	1600 pcs	1800 pcs

# ST-18 | 3RUNNER



MADE IN U.A.E

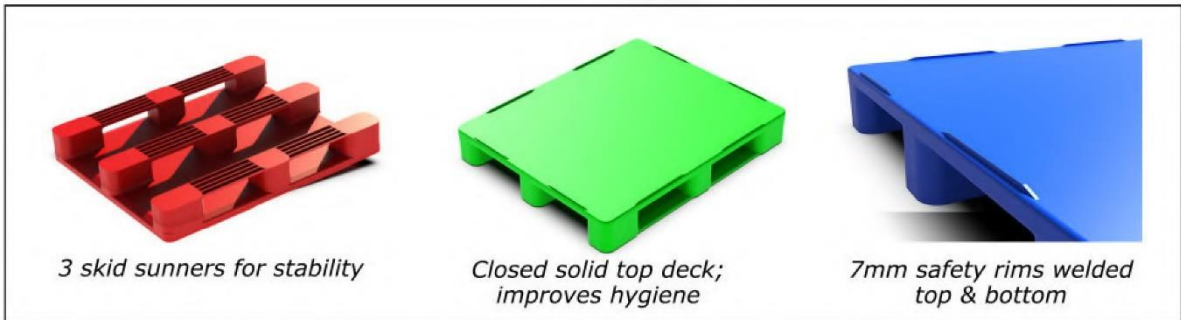

3 skid sunners for stability

Closed solid top deck; improves hygiene

7mm safety rims welded top & bottom

\*with / without rim (optional)

### TECHNICAL SPECIFICATION

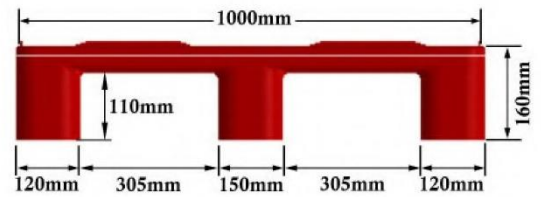
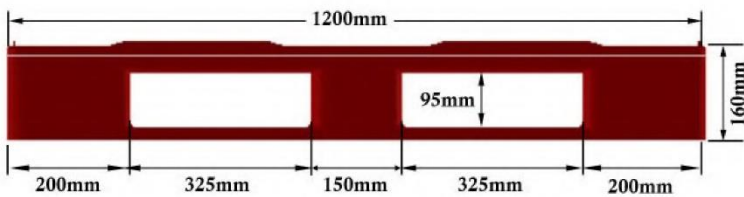

TECHNICAL DATA			
Dimension(mm)	L:1200 x W:1000 x H:160		
Material	HDPE / PP		
Color			
Loading Capacity (Kgs) : ST-18 3R	STATIC	DYNAMIC	RACKING
	7500 Kg	1500 Kg	1250 Kg
Item Code / Barcode	<small>*depends upon the span width</small>		

Load Quantity	20 ft	40 ft	Trailer Truck
	140 pcs	360 pcs	410 pcs

**ST-18 | 5RUNNER**



MADE IN U.A.E

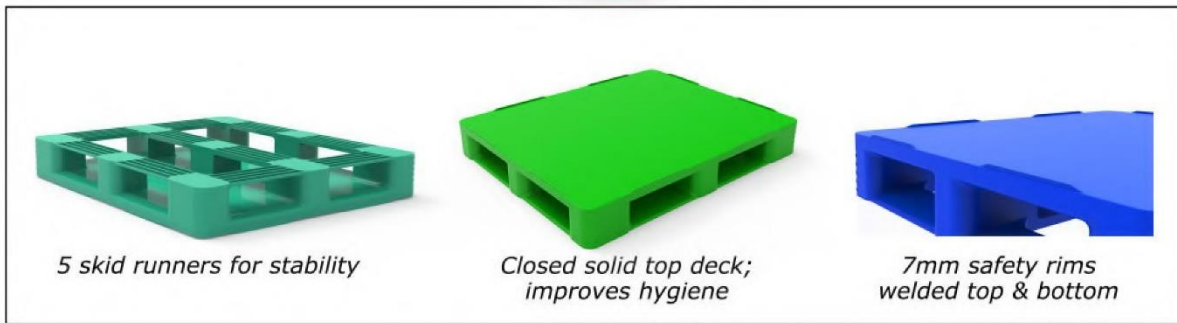

*5 skid runners for stability*

*Closed solid top deck; improves hygiene*

*7mm safety rims welded top & bottom*

**TECHNICAL SPECIFICATION**

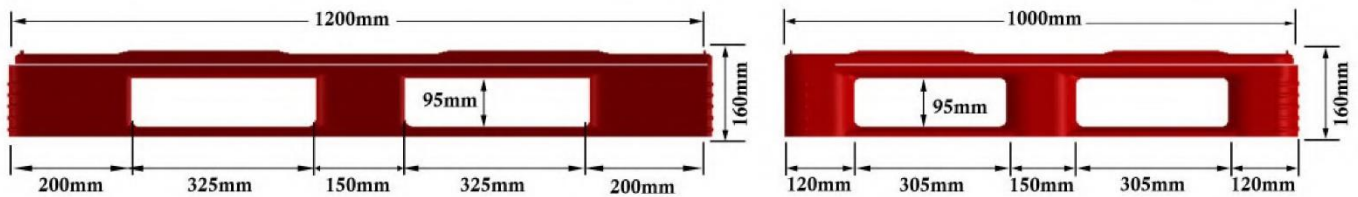

**TECHNICAL DATA**

Dimension(mm)	L:1200 x W:1000 x H:160		
Material	HDPE / PP		
Color			
Loading Capacity (Kgs) : ST-18 5R	STATIC	DYNAMIC	RACKING
	7500 Kg	1500 Kg	1250 Kg*
Item Code / Barcode	*Optional steel profile to make racking loading capacity upto 1500 kg.		

Load Quantity	20 ft	40 ft	Trailer Truck
	140 pcs	360 pcs	410 pcs

# ST-19 | 3RUNNER



MADE IN U.A.E



### TECHNICAL SPECIFICATION

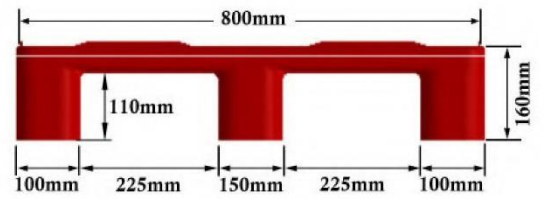
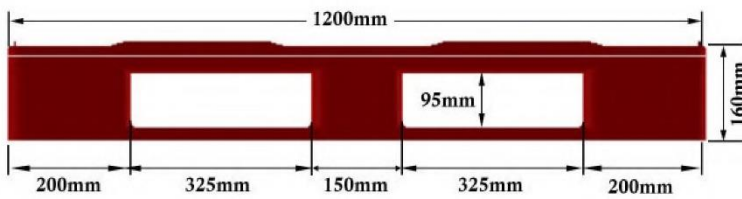

### TECHNICAL DATA

Dimension(mm)	L:1200 x W:800 x H:160		
Material	HDPE / PP		
Color			
Loading Capacity (Kgs) : ST-19 3R	STATIC	DYNAMIC	RACKING
	5000 Kg	1500 Kg	1000 Kg*
Item Code / Barcode	*Optional steel profile to make racking loading capacity upto 1500 kg.		

Load Quantity	20 ft	40 ft	Trailer Truck
	260 pcs	580 pcs	600 pcs



# ST-20 | 9 LEG PALLET

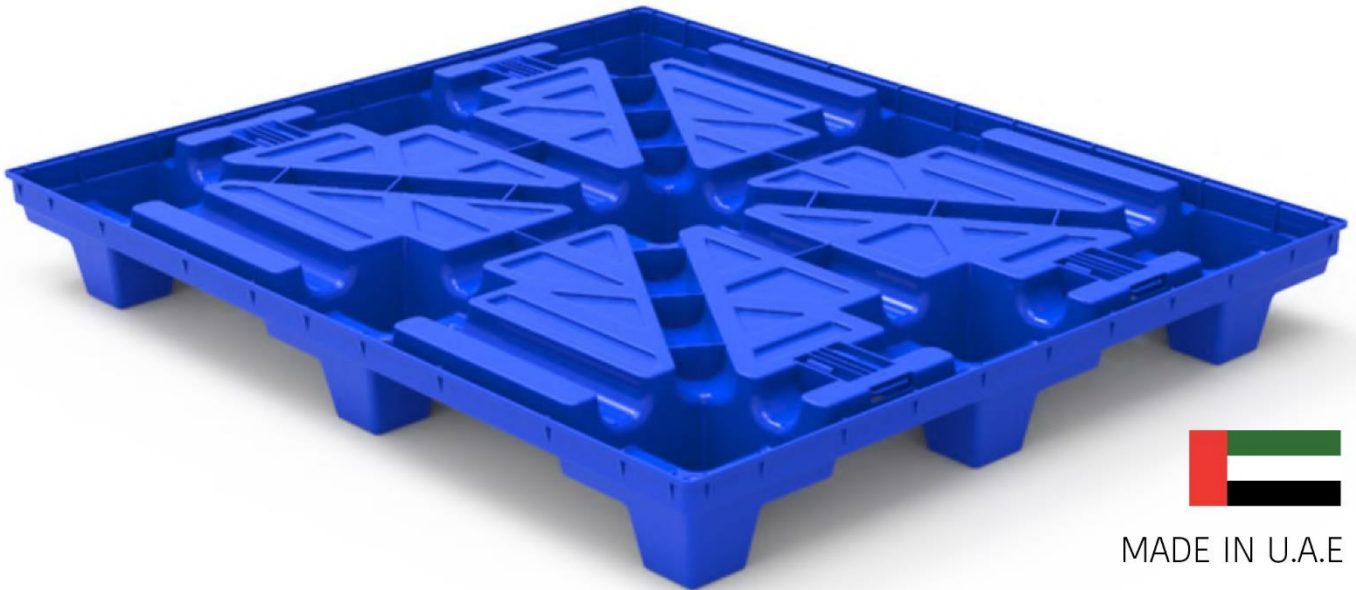

MADE IN U.A.E

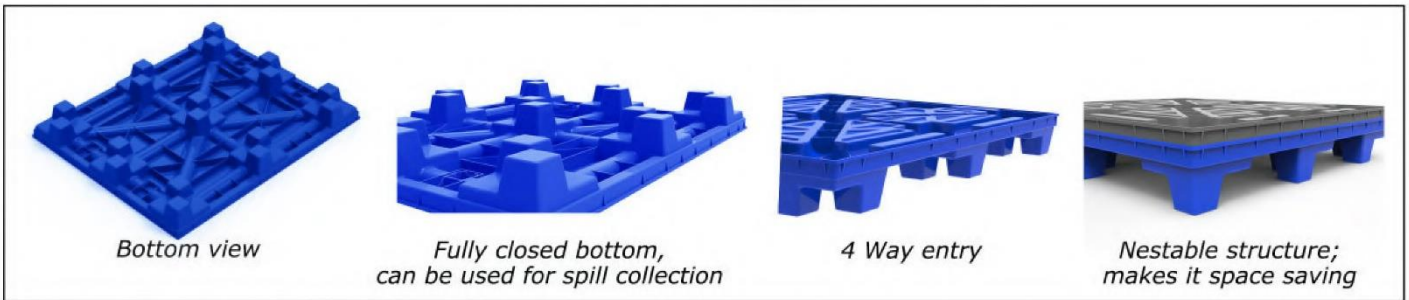

Bottom view

Fully closed bottom, can be used for spill collection

4 Way entry

Nestable structure; makes it space saving

### TECHNICAL SPECIFICATION

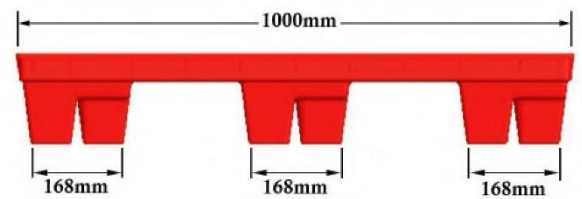
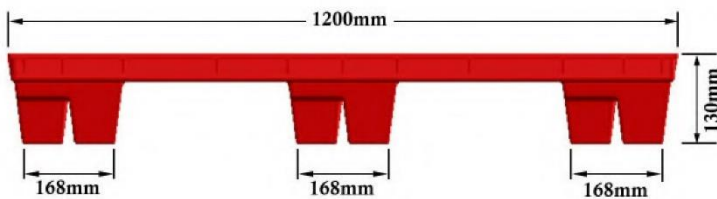

TECHNICAL DATA			
Dimension(mm)	L:1200 x W:1000 x H:130		
Material	HDPE / PP		
Color			
Loading Capacity (Kgs) : ST-20	STATIC	DYNAMIC	RACKING
	2000 Kg	1000 Kg	N/A
Item Code / Barcode			

Load Quantity	20 ft	40 ft	Trailer Truck
	500 pcs	1400pcs	1500 pcs

**SP-4 | SPILL PALLET**



**SP-4L**



**SP-4H**



MADE IN U.A.E



*Specially designed to hold 4 drums*

**TECHNICAL DATA**

	<b>SP-4L</b>	<b>SP-4H</b>
Dimension(mm)	L:1300 x W:1300 x H:150	L:1300 x W:1300 x H:300
Color	Yellow With Black Removable Grid	Yellow With Black Removable Grid
Sump Capacity	167 Ltr	200 Ltr
Static Load	2700 Kg	2700 Kg
Item Code / Barcode		

**FEATURES :**

- Σ Each unit can store upto 4 standard 205 Ltr drums.
- Σ Injection molded polyethylene floor.
- Σ Inbuilt with incorporating UV stabilizers.
- Σ Ideal for in storage location.

**SP-2 | SPILL PALLET**



**SP-2L**



MADE IN U.A.E



**SP-2H**



*Specially designed to hold 2 drums*

TECHNICAL DATA		
	<b>SP-2L</b>	<b>SP-2H</b>
Dimension(mm)	L:1300 x W:670 x H:150	L:1300 x W:670 x H:300
Color	Yellow With Black Removable Grid	Yellow With Black Removable Grid
Sump Capacity	83 Ltr	150 Ltr
Static Load	1300 Kg	1300 Kg
Item Code / Barcode		

**FEATURES :**

- Σ *Designed to hold 2 X 205 Ltr drums.*
- Σ *Manufactured from medium density polyethylene.*
- Σ *Made by incorporating UV stabilizers.*
- Σ *Removable inner grid.*

**SP-1 | SPILL PALLET**



**SP-1L**



MADE IN U.A.E



**SP-1H**



*Specially designed to hold 1 drum*

**TECHNICAL DATA**

	<b>SP-1L</b>	<b>SP-1H</b>
Dimension(mm)	L:670 x W:670 x H:150	L:900 x W:700 x H:525
Color	Yellow With Black Removable Grid	Yellow With Black Removable Grid
Sump Capacity	43 Ltr	225 Ltr
Static Load	680 Kg	300 Kg
Item Code / Barcode		

**FEATURES :**

- Σ Designed to hold 1 X 205 Ltr drums.
- Σ Injection moulded polyethylene sump pallet with inbuilt UV stabilizers.
- Σ Broadband chemical compatibility.
- Σ Removable grid inlay.

**PALLET BOX | PB | HEAVY DUTY SERIES**



MADE IN U.A.E



Specifications						
Art #	Dimensions (cm) (L x W x H)		Capacity Ltr	Weight Kg	Material	Loading (static) Kgs
	External	Internal				
PB 1210	120 x 100 x 76	110 x 91 x 60.5	610 Ltr	38.5 Kg (+/-700 grms)	HDPE	4800 Kg
	120 x 100 x 58	110 x 91 x 42.5	430 Ltr	32.5 Kg (+/-700 grms)		
PB 1208	120 x 80 x 76	111 x 71 x 60	470 Ltr	31.5 Kg (+/-700 grms)	HDPE	4300 Kg
	120 x 80 x 58	111 x 71 x 42.5	330 Ltr	27 Kg (+/-700 grms)		



**ACCESSORIES**



Tap



Discharge Cap



Lids



Wheels



Runners

**PALLET BOX | PB | COLLAPSIBLE**



**LIGHT DUTY PALLET BOX**



MADE IN U.A.E



Specifications						
Art #	Dimensions (cm) (L x W x H)		Capacity Ltr	Weight Kg	Material	Loading (static) Kgs
	External	Internal				
PBF 1210 L	120 x 100 x 75	113 x 93 x 50	525 Ltr	25 Kg (+/-100 grms)	HDPE	250 Kg
	120 x 100 x 115	113 x 93 x 90	945 Ltr	26 Kg (+/-100 grms)		
PBF 1210 H	120 x 100 x 100	112 x 92 x 83	855 Ltr	42 Kg (+/-500 grms)	HDPE	4000 Kg
	120 x 100 x 86	112 x 92 x 69	710 Ltr	40 Kg (+/-700 grms)		



**HAEVY DUTY PALLET BOX**



## MINI JUMBO CRATE

1059X368X252MM

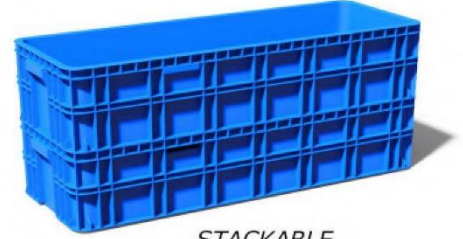

STACKABLE



MADE IN U.A.E



TOUGH HANDLE

TECHNICAL DATA	
DIM-External (mm)	L:1059 x W:368 x H:252 MM
Material	HDPE / PP
Color	
Capacity	95 Ltr
Type	Closed Crate
Item Code / Barcode	

## JUMBO CRATE(XL)

1286X462X314MM



Characteristic bottom ribs for heavy usage



TOUGH HANDLE

TECHNICAL DATA	
DIM-External (mm)	L:1286 x W:462 x H:314 MM
Material	HDPE / PP
Color	
Capacity	186 Ltr
Type	Closed Crate
Item Code / Barcode	

**TOAST CRATE**  
**750X650X150MM**



STACKABLE



MADE IN U.A.E



NESTABLE

TECHNICAL DATA	
DIM-External (mm)	L:750 x W:650 x H:150 MM
Material	HDPE / PP
Color	
Type	Total Perforated
Item Code / Barcode	

**TOAST CRATE SMALL**  
**658X553X120MM**



NESTABLE



STACKABLE

TECHNICAL DATA	
DIM-External (mm)	L:658 x W:553 x H:120 MM
Material	HDPE / PP
Color	
Type	Total Perforated
Item Code / Barcode	



**FISH CRATE**  
**600X400X350MM**



LID (Optional)



MADE IN U.A.E



3 IN 1 PACKING

TECHNICAL DATA	
DIM-External (mm)	L:600 x W:400 x H:350 MM
Material	HDPE / PP
Color	
Capacity	84 Ltr
Type	Completely Closed With Side Handle Hole
Item Code / Barcode	

**CLOSED CRATE**  
**650X435X365MM**



NESTABLE



STACKABLE

TECHNICAL DATA	
DIM-External (mm)	L:650 x W:435 x H:365 MM
Material	HDPE / PP
Color	
Capacity	103 Ltr
Type	Closed Crate
Item Code / Barcode	

**600X400X280MM**



**CLOSED CRATE**



LID (Optional)

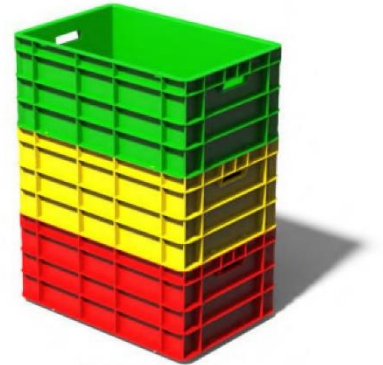

STACKABLE



MADE IN U.A.E



**VENTILATED CRATE**



SIDE HANDLE HOLE

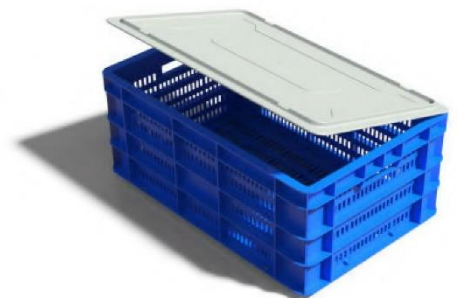

LID (Optional)

TECHNICAL DATA	
DIM-External (mm)	L:600 x W:400 x H:280 MM
Material	HDPE / PP
Color	
Capacity	67 Ltr
Type	Closed / Ventilated
Item Code / Barcode	

**600X400X220MM**



**CLOSED CRATE**



*LID (Optional)*



*STACKABLE*



MADE IN U.A.E



**VENTILATED CRATE**



*STACKABLE*

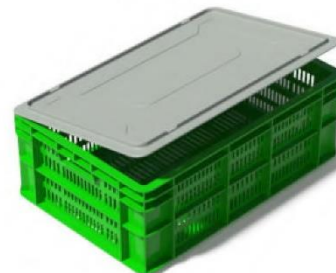

*LID (Optional)*

TECHNICAL DATA	
DIM-External (mm)	L:600 x W:400 x H:220 MM
Material	HDPE / PP
Color	● ● ● ● ● ●
Capacity	52 Ltr
Type	Closed / Ventilated
Item Code / Barcode	

**600X400X170MM**

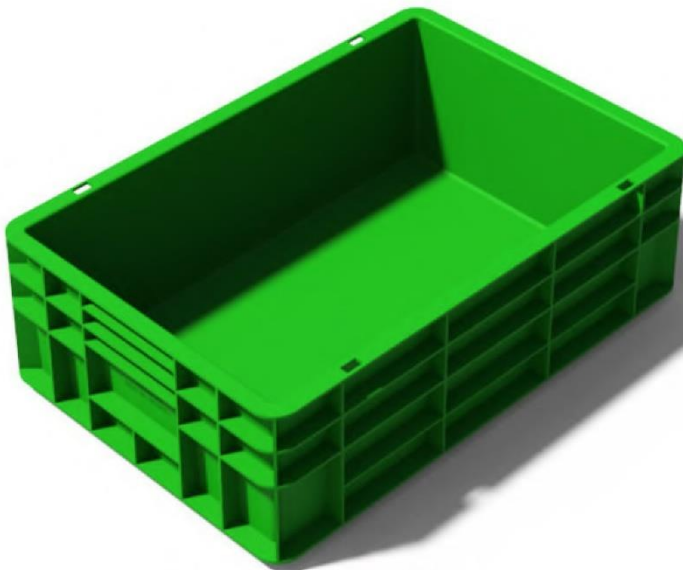

**CLOSED CRATE**



*LID (Optional)*

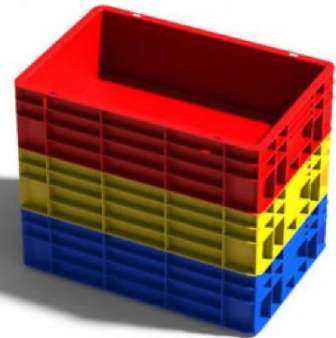

*STACKABLE*



MADE IN U.A.E

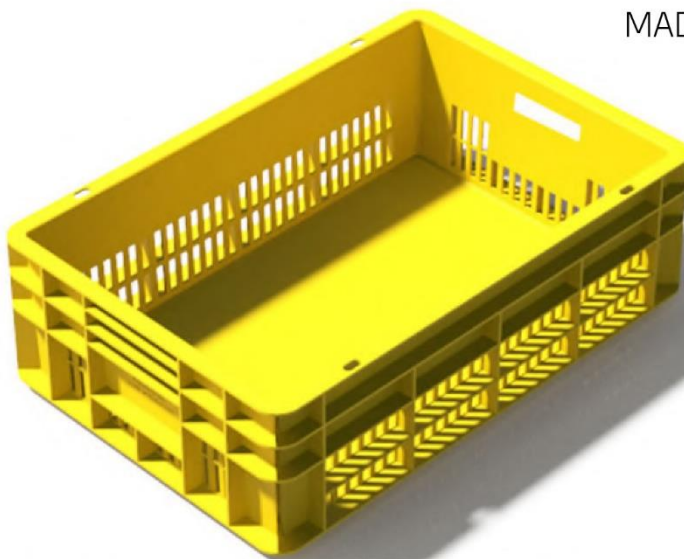

**VENTILATED CRATE**



*SIDE HANDLE HOLE*



*V-cut option*

TECHNICAL DATA	
DIM-External (mm)	L:600 x W:400 x H:170 MM
Material	HDPE / PP
Color	● ● ● ● ● ●
Capacity	40 Ltr
Type	Closed / Ventilated
Item Code / Barcode	

**600X400X120MM**



**CLOSED CRATE**



*LID (Optional)*

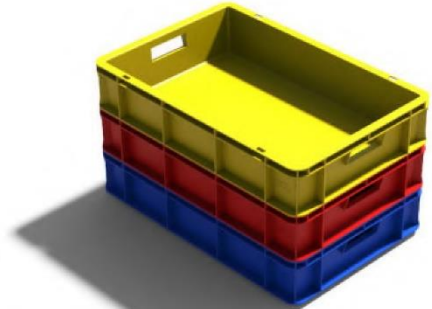

**STACKABLE**



MADE IN U.A.E



**VENTILATED CRATE**

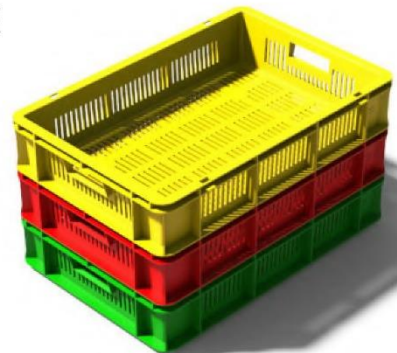

**STACKABLE**



*LID (Optional)*

TECHNICAL DATA	
DIM-External (mm)	L:600 x W:400 x H:120 MM
Material	HDPE / PP
Color	
Capacity	29 Ltr
Type	Closed / Ventilated
Item Code / Barcode	

**600X400X80MM**



**CLOSED CRATE**

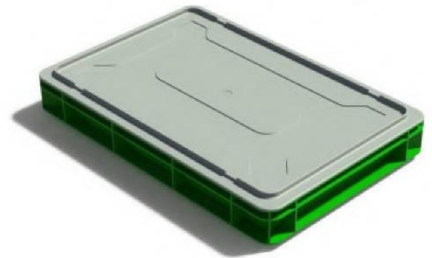

*LID (Optional)*

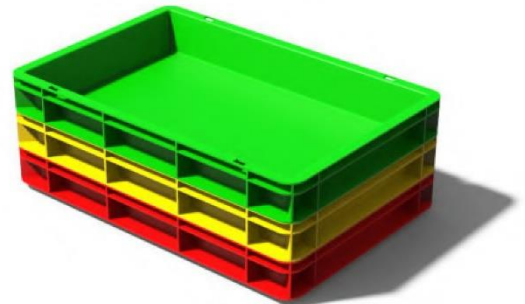

STACKABLE



MADE IN U.A.E



**VENTILATED CRATE**



STACKABLE



*LID (Optional)*

TECHNICAL DATA	
DIM-External (mm)	L:600 x W:400 x H:80 MM
Material	HDPE / PP
Color	● ● ● ● ● ●
Capacity	20 Ltr
Type	Closed / Ventilated
Item Code / Barcode	

# LIVE CHICKEN CAGE

953X575X292MM

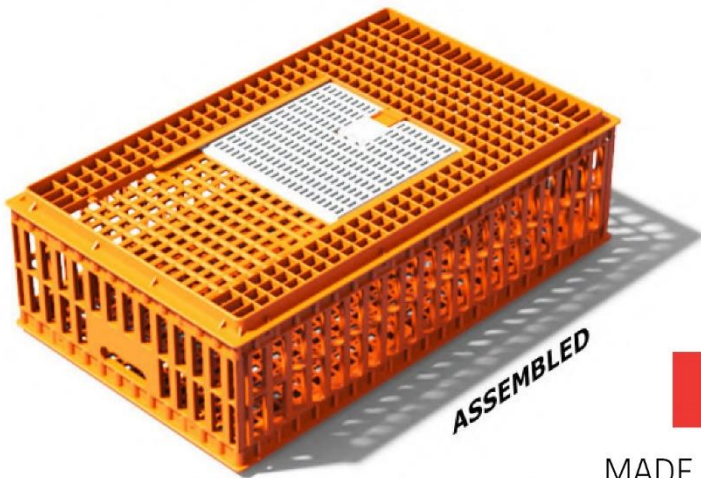

ASSEMBLED



MADE IN U.A.E



DISASSEMBLED

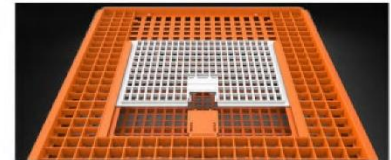

SLIDING WINDOW ON TOP  
DIM : 260 X 315 MM



TECHNICAL DATA	
DIM-Assembled (mm)	L:953 x W:575 x H:292 MM
DIM-Disassembled (mm)	L:953 x W:575 x H:110 MM
Color	<span style="color:blue">●</span> <span style="color:green">●</span> <span style="color:red">●</span> <span style="color:yellow">●</span> <span style="color:black">●</span> <span style="color:orange">●</span>
Material	HDPE / PP
Unit Weight	8.0 Kgs
Item Code / Barcode	

# CHICK BASKET

690X480X155MM



STACKABLE



NESTABLE

TECHNICAL DATA	
DIM-External (mm)	L:690 x W:480 x H:155 MM
Material	HDPE / PP
Color	<span style="color:orange">●</span>
Compartments	4
Type	Side Ventilated
Item Code / Barcode	



**MILK CRATE-LARGE**

**425X335X335MM**



MADE IN U.A.E



STACKABLE



SPACE FOR LOGO EMBOSSING

TECHNICAL DATA	
DIM-External (mm)	L:425 x W:335 x H:335 MM
Material	HDPE / PP
Color	
Capacity	47 Ltr
Type	Total Perforated
Item Code / Barcode	

**JUMBO MILK CRATE**

**480X330X330MM**



STACKABLE

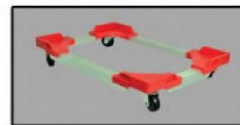

4 WHEEL TROLLEY (Optional)

TECHNICAL DATA	
DIM-External (mm)	L:480 x W:330 x H:330 MM
Material	HDPE / PP
Color	
Capacity	52 Ltr
Type	Total Perforated
Item Code / Barcode	



**MILK CRATE-SMALL**

**400X325X310MM**



MADE IN U.A.E



STACKABLE

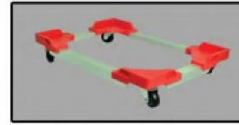

4 WHEEL TROLLEY (Optional)

TECHNICAL DATA	
DIM-External (mm)	L:400 x W:325 x H:310 MM
Material	HDPE / PP
Color	
Capacity	40 Ltr
Type	Total Perforated
Item Code / Barcode	

**MILK CRATE-MEDIUM**

**425X335X310MM**

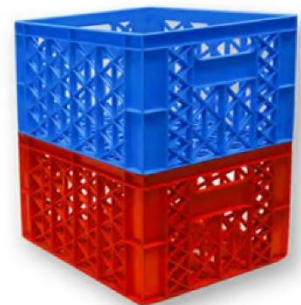

STACKABLE



SPACE FOR LOGO EMBOSSING

TECHNICAL DATA	
DIM-External (mm)	L:425 x W:335 x H:310 MM
Material	HDPE / PP
Color	
Capacity	44 Ltr
Type	Total Perforated
Item Code / Barcode	

**DATES CRATE (NESTING CRATE)**

**585X385X210MM**



MADE IN U.A.E



SPECIAL CENTRAL LEG SUPPORT



STACKABLE

TECHNICAL DATA	
DIM-External (mm)	L:585 x W:385 x H:210 MM
Material	HDPE / PP
Color	
Capacity	47 Ltr
Type	Perforated
Item Code / Barcode	

**NESTING CRATE**

**600X400X150MM**

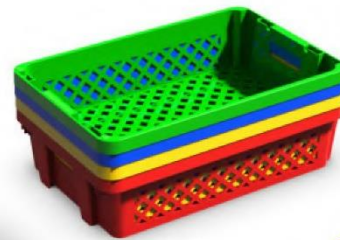

NESTABLE



STACKABLE

TECHNICAL DATA	
DIM-External (mm)	L:600 x W:400 x H:150 MM
Material	HDPE / PP
Color	
Type	Total Perforated
Item Code / Barcode	

**NESTING CRATE**

**585X385X210**



NESTABLE



MADE IN U.A.E



STACKABLE

**VENTILATED CRATE**

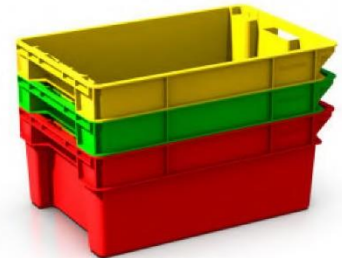
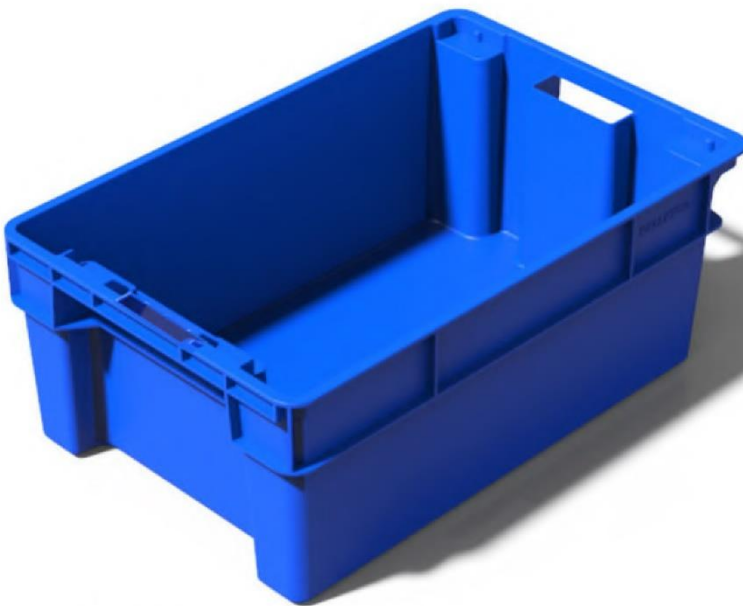

NESTABLE



STACKABLE

**CLOSED CRATE**

TECHNICAL DATA	
DIM-External (mm)	L:585 x W:385 x H:210 MM
Material	HDPE / PP
Color	● ● ● ● ● ●
Capacity	48 Ltr
Type	Closed / Ventilated
Item Code / Barcode	

**BAKERY CRATE**

**590X460X180MM**



MADE IN U.A.E



STACKABLE

TECHNICAL DATA	
DIM-External (mm)	L:590 x W:460 x H:180 MM
Material	HDPE / PP
Color	
Capacity	50 Ltr
Type	Total Perforated
Item Code / Barcode	

**INNER TRAY**

**530X400X120MM**



INNER TRAY (Optional)

TECHNICAL DATA	
DIM-External (mm)	L:530 x W:400 x H:120 MM
Material	HDPE / PP
Color	
Type	Closed
Item Code / Barcode	



www.starsage.lk

## **READY MORTAR SKIP**

**1660X850X813MM**



MADE IN U.A.E



*Specially designed for crane handling*



*Robust trolley ensures smooth operations*



*For ready mortar applications*

### TECHNICAL DATA

DIM-Outer (mm)	L:1160 x W:850 x H:815 MM
DIM-Inner (mm)	L:1145 x W:850 x H:815 MM
Color	
Capacity	200 LTR
Load Capacity	430 KG
Item Code / Barcode	

World of



# Starsage

www.starsage.lk

## WATER RACK | U-TYPE



MADE IN U.A.E



### TECHNICAL SPECIFICATION

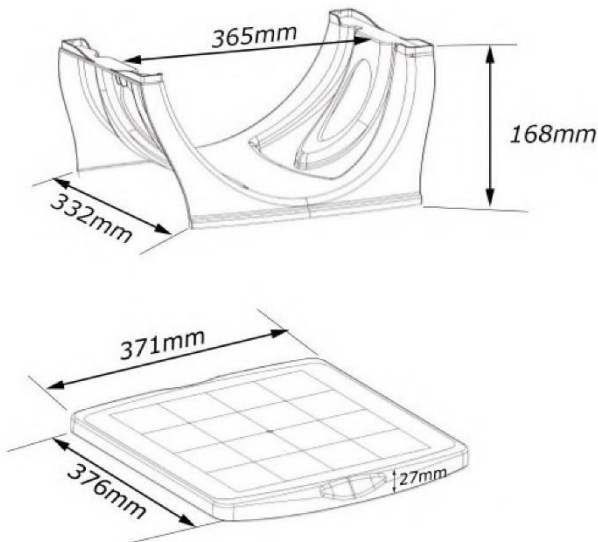

SUITABLE FOR 5 GALLON  
WATER BOTTLES



NESTABLE

### TECHNICAL DATA

	U RACK	UPPER SHELF
Dimension(mm)	L:365 x W:332 x H:168	L:376x W:370 x H:27
Material	HDPE	HDPE
Weight	0.54 KG (+/-3%)	0.51 KG (+/-3%)
Item Code / Barcode		

World of



**Starsage**

www.starsage.lk

**WATER RACK | 5 GALLON**



MADE IN U.A.E



Reach through feature



Forklift layer slots

**TECHNICAL SPECIFICATION**

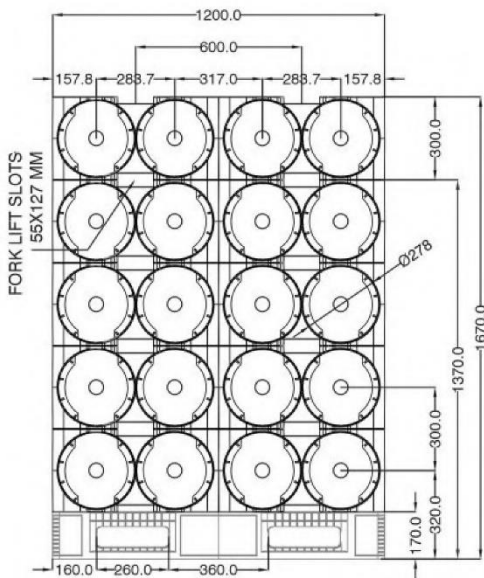

**TECHNICAL DATA**

	<b>PALLET</b>	<b>WATER RACK (ONE UNIT)</b>
Dimension(mm)	L:1200 x W:1000 x H:170	L:1000 x W:600 x H:300
Material	HDPE	HDPE
Weight	17 KG (+/-3%)	12 KG (+/-3%)
Item Code / Barcode		

World of



Starsage

www.starsage.lk

**WATER RACK | 3 GALLON**

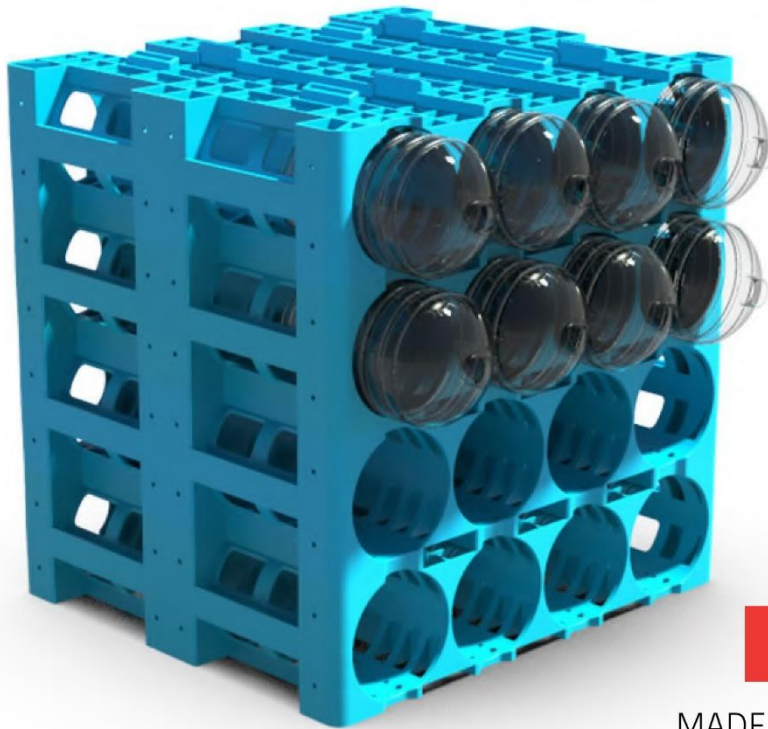

MADE IN U.A.E

**TECHNICAL SPECIFICATION**

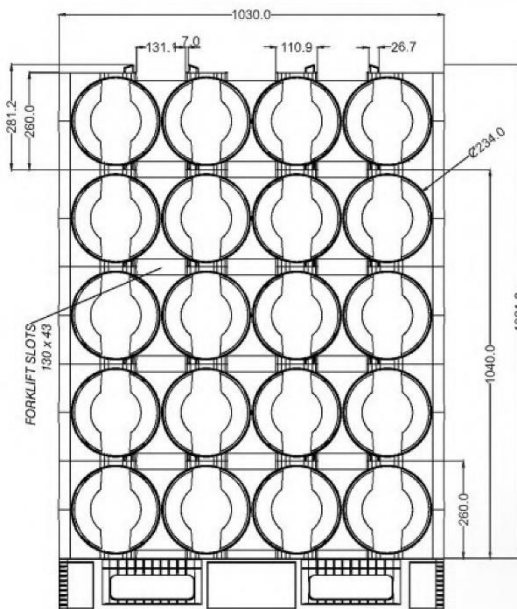

**TECHNICAL DATA**

	<b>PALLET</b>	<b>WATER RACK (ONE UNIT)</b>
Dimension(mm)	L:1030 x W:900 x H:150	L:1030 x W:900 x H:260
Material	HDPE	HDPE
Weight	17 KG (+/-3%)	17 KG (+/-3%)
Item Code / Barcode		



**IBC TANK | 1200X1000X1175**



**IBC TANK WITH STEEL BASE**



MADE IN U.A.E

Technical Data	
DIM-External (mm)	L:1200 x W:1000 x H:1175
Material	PC / PP
Color	Wh ite
Capacity	1000 Ltr



**IBC TANK WITH PLASTIC PALLET**

**DRUMS**



The lids for open top drums are injection molded in black color with high density polyethylene



Technical Data				
Capacity	50 Ltrs	120 Ltrs	220 Ltrs	220 Ltrs-closed top
DIM-External (mm)	W:374 x H:605	W:460 x H:840	W:570 x H:960	W:570 x H:935
Color	● ● ●	● ● ●	●	●
Material	PC / PP	PC / PP	PC / PP	PC / PP

World of



# Starsage

www.starsage.lk

## CHICKEN CAGE-DRAWER

### 1160X770X255MM



MADE IN U.A.E



*Can be kept well arranged*



*Semi-perforated for ventilation*

### TECHNICAL SPECIFICATION

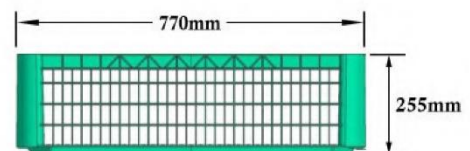
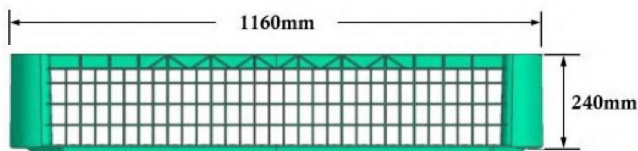

TECHNICAL DATA	
DIM-External (mm)	L:1160 x W:770 x H:255 MM
Material	HDPE / PP
Color	
Type	Total Perforated
Item Code / Barcode	

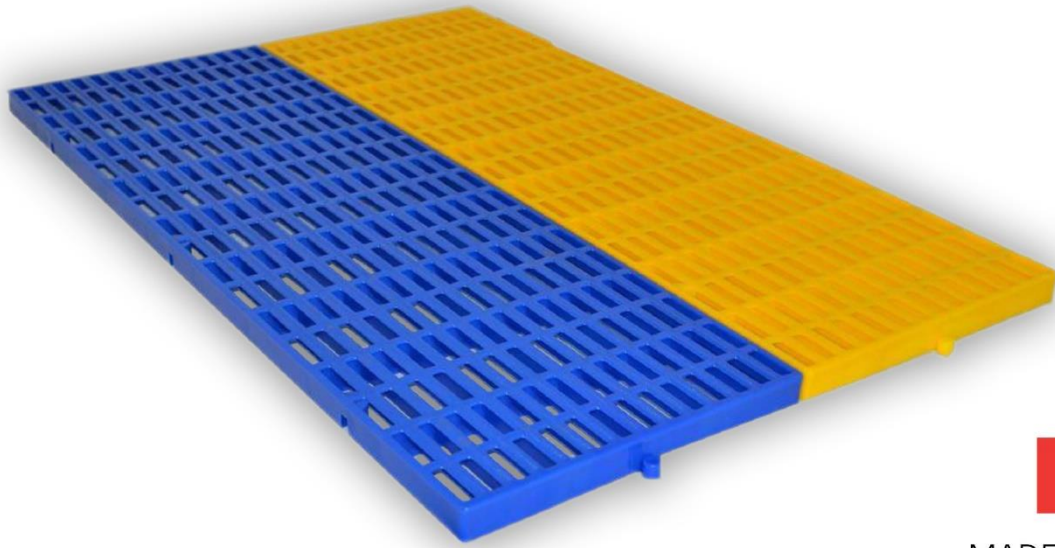

MADE IN U.A.E

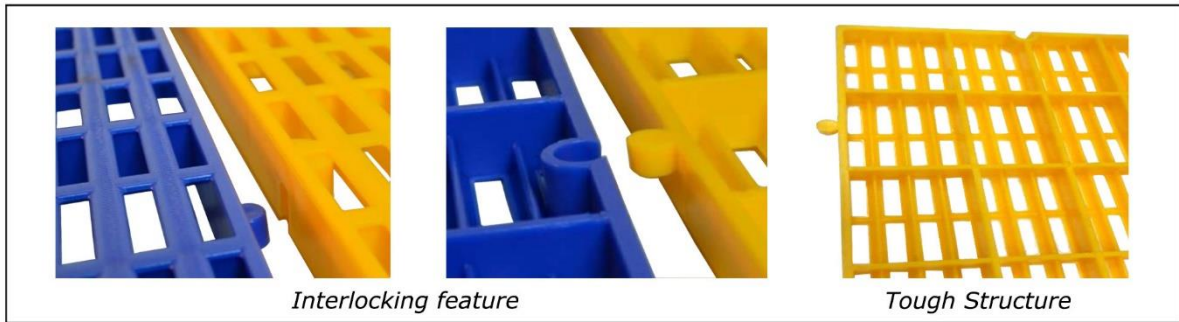

Interlocking feature

Tough Structure

### TECHNICAL DATA

Dimension(mm)	L:900x W:300 x H:30		
Material	HDPE / PP		
Color			
Weight (Kgs)	1.6 kg		

### FEATURES

- Light weight, durable, strong and long lasting.
- Water proof with color guard.
- Suitable for common wet areas (Swimming pools, washrooms etc.)
- Convenient sizes with interlocking feature.
- Suitable for area of any dimensions.
- Vibrant colors.
- Ideal for soak ways.



MADE IN U.A.E

World of



# PLASTIC INSULATED CONTAINERS | FOR FISH INDUSTRY [www.starsage.lk](http://www.starsage.lk)

These insulated plastic containers are the most popular & frequently used in the food processing (fish, shrimp & meat) sectors for storages & keeping fresh during preparation. The pallet designed at bottom can be moved by a standard hand pallet jack and forklift truck from all four sides. 1250 litre & 1700 litre is suitable for storage of large fish i.e. Tuna.



Capacity	External Dimensions (mm)	Internal Dimensions (mm)
600 litre	L1235 x W1050 x H790	L1150 x W960 x H560
800 litre	L1180 x W1180 x H990	L1080 x W1080 x H745
1000 litre	L1480 x W1145 x H1015	L1390 x W1055 x H775
1000 litre (L+)	L1225 x W1090 x H1205	L1115 x W980 x H960
1250 litre	L1990 x W1170 x H970	L1870 x W1050 x H665
1700 litre	L2250 x W1160 x H1160	L2110 x W1020 x H850



## Contact Us.



Starsage Holdings (Pvt) Ltd.

Head Office: No:104/01 Kerawalapitiya Rd,  
Hendala, Wattala, Colombo, Sri Lanka.

Warehouse: 146/6f Peal Park,  
Wattala, Colombo, Sri Lanka.

Tel: +94 11 2942020, +94 11 3039966

Fax: +94 11 2942020

E-mail: [packaging@starsage.lk](mailto:packaging@starsage.lk)

Web: [www.starsage.lk](http://www.starsage.lk)



### MAP TO STARSAGE HOLDINGS (PVT) LTD - HEAD OFFICE

